

# PLANKTON DIATOMS OF THE JAVA SEA

BY

WINFRED EMORY ALLEN AND EASTER ELLEN CUPP

The Scripps Institution of Oceanography of the University of California  
(located at La Jolla, near San Diego, California, U.S.A)

---

## INTRODUCTION

Due to the courtesy and active interest of DR. H. C. DELSMAN, Director of the Laboratory for Exploration of the Sea at Batavia, Java, the Scripps Institution of Oceanography at La Jolla, California, received in October 1929 a collection of catches of plankton diatoms taken by DR. DELSMAN in connection with his investigations of pelagic fish eggs and larvae in the Java Sea. That collection was passed by Director T. WAYLAND VAUGHAN of the Scripps Institution to the senior author of this paper for examination. The specimens found in the included catches proved to be very valuable for comparison with the plankton diatoms observed in studies of distribution in the north east Pacific Ocean and the authors of this paper prepared from them a tentative list of species which, at the invitation of DR. DELSMAN, has been expanded into the following report on identification of the included forms.

In preparing the report Professor ALLEN has contributed little beyond writing this introduction and supervising the work. Miss CUPP has contributed all of the illustrations and the arduous routine work of writing keys and diagnoses, consulting authorities, and verifying references and comparisons.

Since our studies of seasonal, geographical and bathymetrical distribution of plankton diatoms require examination of untreated specimens in great numbers, under comparatively low magnification by the micro-

scope, we (the authors) are strongly impressed with the desirability of presenting a report that will be useful for those wishing to undertake similar studies of marine plankton diatoms in other localities. For that reason we have simplified the treatment as much as was practicable, both in respect to discussion and illustrations, and we have tried to include in each diagnosis a form of statement that may enable an observer to identify a specimen without special treatment or high magnification. Unfortunately, there are many species which cannot be recognized by simple methods of treatment. For them satisfactory identification is only possible when specimens in good condition are obtainable and when these can be cleaned and mounted for examination at high magnifications.

Although drawings or photographs of all species included in this report have been published in earlier papers or reports by other observers, we are giving an original drawing for each because our experience has shown that different workers show larger or smaller differences in their illustrations of a particular species and that these differences in illustration are often very helpful toward identification by observers unfamiliar with certain species characters. All the drawings for this report have been made by aid of a camera lucida, in practically all instances from specimens mounted in the synthetic resin "Hyrax" developed by DR. G. DALLAS HANNA of the California Academy of Sciences, San Francisco, California. This medium is peculiarly suited to use with plankton diatoms and it is probable that the details shown in certain figures cannot be seen so well in any other mounting.

In our daily use of plankton literature we have found that relatively few photographs of plankton diatoms are clear in all of the points which we need to see. On the other hand, we have found that almost all good drawings show the essential characters satisfactorily. Because of such experiences we have used no photographs in illustrating this material.

Our experience has also convinced us that large books or papers and profuse diagnoses of species are difficult to use when they must be consulted quickly and frequently, as is often the case when making quantitative studies of catches. Partly for that reason we have decided to use brief diagnoses and to limit discussion to essential features, thus presenting a paper which may be serviceable as a laboratory guide rather than as a reference book of final authority.

So far as seems appropriate for Java material, we have followed the order and method of treatment used by HUSTEDT in DR. L. RABEN-

HORST's "Kryptogamen-Flora von Deutschland, Österreich und der Schweiz", VII. Band, "Die Kieselalgen", Lieferung 1—5 (1928—1930) for the *Centricae*. HUSTEDT in turn has based his classification on that of SCHÜTT in ENGLER and PRANTL, "Die Natürlichen Pflanzenfamilien" (1896). The classification of the *Pennatae* is based directly on that of SCHÜTT. GRAN, "Diatomeen" in "Nordisches Plankton" (1905) and LEBOUR, "The Planktonic Diatoms of Northern Seas" (1930, Ray Society) have also been used to a considerable extent. Since these books are generally accessible and since they give excellent discussions of relationship, synonymy, and existence of planktonic diatoms, we refer to them instead of taking space for similar explanations.

---

### PLANKTON DIATOMS

Along the California coast and other parts of the north east Pacific Ocean there are days in the first half of almost every year when one can dip a liter of water from the sea, pass it through a fine woven cloth or other filter, and find on the surface of the filter, after the water has passed, a brown or greenish brown film of slimy material. This may be found to consist almost entirely of plankton diatoms, microscopic plants with chlorophyll more or less hidden by a brown pigment. Placed in a solution of formaldehyde, the slimy mass usually turns and remains green for several hours, after which all color is gradually lost. It is probable that in Javan material likewise the presence of diatoms is indicated at times by such changes in color. However, it is more probable that through most of the year their presence will not be definitely indicated in a plankton catch until a microscope is used on a part of it. Under the microscope most plankton diatoms can be distinguished from other organisms of similar size by the peculiarly stiff appearance of their glass-like coverings (frustules) and of the slender projections from these frustules so often found in plankton types of diatoms. Even when united into thread-like colonies the individual cells retain this stiffness of appearance. However, one entirely strange to diatoms can have little confidence in this ability to pick them out until he has seen representative specimens under the direction of an experienced observer or until he has seen good illustrations of similar specimens.

If, as seems preferable, diatoms can be considered to rank as a Class

Bacillariales (Diatomales) of Algae, they may be said to include two Orders, Centricae, with cells mostly circular, oval or elliptical in outline, and Pennatae, with cells mostly boat-shaped or rod-shaped. In the marine plankton, as in the material upon which this report has been written, there are more species belonging to the second. In this particular group of catches from the Java Sea the Centricae are distinctly more prominent. Of the 127 species and varieties covered by this report 91 belong to the Centricae and 36 to the Pennatae.

TABLE I

Table showing location and depth at which the eleven samples were taken, and the salinity of the water.

Number of Sample	Location		Depth in Meters	Salinity in parts per thousand
	Latitude	Longitude		
I	6° 10' 20" S	107° 50' E	14	26.2
II	6° 12' S	108° 19' E	15	32.6
III	6° 32½' S	108° 12' E	20	32.6
IV	4° 16' S	110° 34' E	43	34.0
V	4° 7' S	110° 45' E	15	32.6
VI	3° 49' S	111° 4' E	35	33.9
VII	3° 34' S	111° 21' E	27	33.8
VIII	3° 25½' S	111° 45½' E	8	33.3
IX	3° 20' S	110° 45' E	45	34.2
X	2° 13½' S	105° 9' E	—	25.8
XI	2° 45' N	100° 3' E	—	29.6

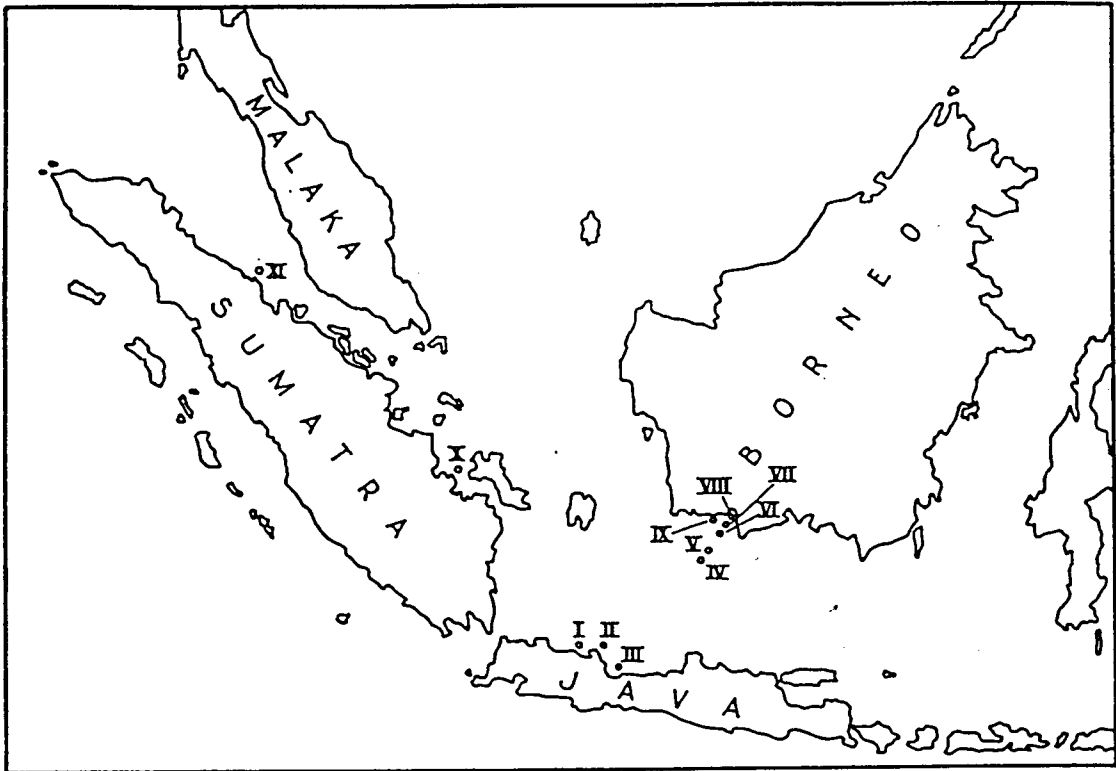

Chart of the western part of the Dutch East Indian Archipelago, showing the stations (I—XI) where the plankton-samples were taken.

TABLE II

Table showing the relative abundance  
of the various species of Diatoms in the eleven samples

Symbols:

rr = very rare

r = rare

+ = present, neither rare nor common

c = common

cc = very common

ccc = abundant

DIATOMS	SAMPLES										
	I	II	III	IV	V	VI	VII	VIII	IX	X	XI
<i>Paralia sulcata</i>	.	.	rr	rr	.	.	.	.	.	rr	.
<i>Stephanopyxis Palmeriana</i>	.	.	.	.	.	.	.	+	.	+	.
<i>Skeletonema costatum</i>	.	.	.	.	.	.	.	.	.	c	c
<i>Coscinosira Oestrupii</i>	.	.	.	.	.	.	.	.	rr	.	.
<i>Coscinodiscus excentricus</i>	.	.	.	.	.	.	.	+	+	+	+
" <i>lineatus</i>	.	.	.	.	.	.	.	.	.	.	+
" <i>marginatus</i>	.	.	.	.	.	.	.	r	.	r	rr
" <i>radiatus</i>	.	.	rr	.	.	.	.	.	.	.	r
" <i>nodulifer</i>	.	.	.	.	.	.	.	r	.	.	.
" <i>Jonesianus</i>	c	.	.	.	.	.	.	+	+	+	+
" var. <i>commutata</i>	.	.	.	.	.	.	.	r	r	.	r
" <i>concinus</i>	.	.	.	.	.	.	.	rr	.	r	rr
" <i>nobilis</i>	cc	+	+	.	.	.	r	r	ccc	+	.
" <i>asteromphalus</i>	.	.	.	.	.	.	.	.	.	.	+
" <i>oculus-iridis</i>	.	.	.	.	.	.	.	.	.	.	r
" <i>gigas</i> var. <i>praetexta</i>	+	c	+	+	c	ccc	ccc	c	c	c	+
" <i>Janischii</i> var. <i>arafurensis</i>	.	.	.	.	.	.	.	.	.	r	.
" <i>subtilis</i>	.	.	.	.	.	.	.	.	r	+	r
<i>Planktoniella sol</i>	rr	rr	.	.	.	.	.	rr	.	rr	.
<i>Actinoptychus undulatus</i>	.	.	.	.	.	.	.	.	.	rr	.
<i>Asterolampra marylandica</i>	.	.	rr	.	.	.	.	.	.	.	.
<i>Asteromphalus flabellatus</i>	.	.	.	.	.	.	.	.	.	rr	.
" <i>Cleveanus</i>	.	.	.	.	.	.	.	.	.	rr	.
<i>Corethron criophilum</i>	.	.	.	.	.	.	.	.	.	+	r
<i>Lauderia annulata</i>	+	+	c	.	.	.	+	+	c	c	c
<i>Schröderella delicatula</i>	r	.	+	.	.	.	.	+	.	+	+
<i>Leptocylindrus danicus</i>	.	.	.	.	.	.	.	.	.	rr	.
<i>Guinardia flaccida</i>	+	+	c	.	+	c	r	+	+	c	+
<i>Rhizosolenia Stolterfothii</i>	.	+	+	.	.	.	r	+	+	c	+
" <i>cylindrus</i>	.	.	.	.	.	.	.	.	.	rr	.
" <i>robusta</i>	.	.	r	.	.	r	rr	r	rr	r	r
" <i>Bergonii</i>	.	.	.	.	.	.	.	.	.	+	.
" <i>arafurensis</i>	.	.	.	.	r	.	.	.	.	r	.
" <i>Clevei</i>	.	r	.	.	.	.	.	r	.	+	.
" <i>imbricata</i>	.	c	.	+	+	+	r	c	+	c	+
" var. <i>Shrubsolei</i>	+	c	.	+	+	+	+	+	c	c	+
" <i>setigera</i>	.	+	+	.	.	.	.	.	+	c	+







## BACILLARIALES

(DIATOMALES)

## KEY

## CENTRICAЕ

- A Valves with a concentric or radiating sculpture around a point or points, central or lateral, never arranged in relation to a middle line, without raphe or pseudoraphe; outline circular, oval, or elliptical, sometimes polygonal, rarely crescent-shaped or spindle-shaped; processes common . . . . . **CENTRICAЕ.**
- I Cells disc-shaped or cylindrical. Valve circular, its surface flat or convex, sometimes hemispherical. Zonal diameter generally shorter than valval. Valve sculpture arranged in relation to a central pole. Spines frequent; horns, when present, small . . . . . **Discoideae.**
- 1 Valves circular. Not divided into definite sectors by ridges or partitions, though sometimes having radial lines of interrupted dashes. More or less long spines often present. . . . . **Coscinodisceae.**
- a Frustules usually united into chains; cells lens-shaped, spherical, or cylindrical. Intercalary bands often sculptured. Valve mantle usually well developed . . . **Melosirinae.**  
 (1) *Paralia* (p. 111)  
 (2) *Stephanopyxis* (p. 112)
- b Cells short or long cylindrical, united in chains by delicate siliceous processes or gelatinous threads. Cell wall usually weakly siliceous . . . . . **Skeletoneminae.**  
 (3) *Skeletonema* (p. 112)  
 (4) *Coscosira* (p. 113)
- c Cells solitary; disc- or drum-shaped. Valve surface slightly convex, rarely strongly convex, sometimes nearly flat or barely concave. Intercalary bands hyaline or in rare cases very delicately dotted. Valve mantle not strikingly developed . . . . . **Coscinodiscinae.**  
 (5) *Coscinodiscus* (p. 113)  
 (6) *Planktoniella* (p. 120)
- 2 Valve circular, divided into complete or incomplete sectors by radiating ridges or wide hyaline rays; no horns or prominent spines . . . . . **Actinodisceae.**
- a Valve divided into sharply distinct sectors by radial ridges uniformly running from the margin to the hyaline central area; small but evident spines usually at the marginal ends of these dividing ridges; alternate sectors generally depressed. . . . . **Actinoptychinae.**  
 (7) *Actinoptychus* (p. 120)

- b Valve sharply divided into sectors by broad hyaline bars or rays running from a hyaline center toward or to the margin, their outer ends marked with a minute spine; the hyaline center divided into more or less wedge-shaped divisions confluent with the rays; spaces between the radiating rays marked with fine but closely set puncta arranged in radial or decussating rows . . . . . **Asterolamprinae.**  
 (8) *Asterolampra* (p. 121)  
 (9) *Asteromphalus* (p. 121)

II Valve oval or circular; cells long-cylindrical, with numerous intercalary bands, without internal septa; cells united into chains by their valves . . . . . **Solenoiidae.**

1 With numerous intercalary bands. . . . . **Solenieae.**

- a Valves flat or raised, with or without marginal spines; excentric process absent . . . . . **Lauderiinae.**  
 (10) *Corethron* (p. 122)  
 (11) *Lauderia* (p. 123)  
 (12) *Schröderella* (p. 123)  
 (13) *Leptocylindrus* (p. 124)

- b Valves flat or convex, with a single, often short, process usually excentrically placed, thus destroying the symmetry of the valve . . . . . **Rhizosoleniinae.**  
 (14) *Guinardia* (p. 124)  
 (15) *Rhizosolenia* (p. 125)

III Cell box-shaped, perivalval axis generally shorter, sometimes slightly longer, than the valval axis; valve usually oval, sometimes polygonal, circular or semicircular; unipolar, bipolar, or multipolar, each pole represented by an angle or by a horn or spine or by both angles and horns. . . **Biddulphioideae.**

1 Valves with long setae, longer than the cell. Cells united in chains by the basal part of the setae. Valve circular or oval. Seldom solitary . . . . . **Chaetocereae.**  
 (16) *Bacteriastrum* (p. 131)  
 (17) *Chaetoceras* (p. 133)

2 Horns thick, generally shorter than the cell; when longer only slightly so and then tipped with a claw. United in chains by the ends of the horns . . . . . **Biddulphiidae.**

(i) Horns without claws on the end.

- a Valves bipolar. Cell wall weakly siliceous . . . **Eucampiinae.**  
 (18) *Eucampia* (p. 142)  
 (19) *Climacodium* (p. 142)  
 (20) *Streptotheca* (p. 143)

- b Valves tripolar to multipolar, sometimes with bipolar varieties. Angles not bearing dome-like protrusions or horns . . . . . **Triceratiinae.**  
 (21) *Bellerochea* (p. 143)  
 (22) *Ditylum* (p. 144)

- c Valves generally bipolar, sometimes tripolar to multipolar, each angle with a dome-like protrusion or a horn. Usually strongly siliceous . . . . . **Biddulphiinae.**  
 (23) *Biddulphia* (p. 145)
- (ii) Horns with claws on the end.  
 a Valve bipolar, tripolar or quadripolar. . . . . **Hemiaulinae.**  
 (24) *Cerataulina* (p. 148)  
 (25) *Hemiaulus* (p. 149)
- 3 Cells without horns; valve without internal septa, semi-circular, broader than long; cell in girdle view cuneate . **Euodiae.**  
 (26) *Hemidiscus* (p. 150)

### PENNATAE

- B** Valve not centrally built; not arranged in relation to a central point, but to a median line. Outline generally boat-shaped or rod-shaped, sometimes oval, cuneate, crescent-shaped, or sigmoid; markings generally pinnate or transverse. True raphe, or hyaline median line (pseudoraphe), or raphe obscured by lateral wings or keel (cryptoraphe) always present. Processes such as horns, spines, etc. uncommon. Cell capable of spontaneous movement if a true raphe is present . . . . . **PENNATAE.**
- I.** No true raphe; a hyaline median line (pseudoraphe) present; rarely obscure . . . . . **Fragilarioideae.**
- 1 Cells solitary or united into a fan or forming a spiral band; not forming a ribbon or zigzag chain. Outline in girdle view rod-shaped; valve club-shaped . . . . . **Meridioneae.**  
 (1) *Licmophora* (p. 151)
- 2 Cells united to form a ribbon or zigzag chain. Girdle composed of separate bands . . . . . **Fragillarieae.**  
 a Sagittal line median. Valve without transverse septa. **Fragillariinae.**  
 (2) *Raphoneis* (p. 152)  
 (3) *Thalassiothrix* (p. 152)  
 (4) *Asterionella* (p. 153)
- II** Cell having one valve with true raphe, the other with distinct or obscure hyaline median line (pseudoraphe) . . . **Achnanθοideae.**
- 1 Cell in girdle view straight; outline of valve broad-oval or nearly round . . . . . **Cocconeideae.**  
 (5) *Campyloneis* (p. 154)
- III** Both valves with a raphe. Raphe generally evident. Valve generally not keeled; if keeled, the raphe coincident with the keel . . . . . **Naviculoideae.**
- 1 Valve with evident raphe; keel generally absent or, when present, without punctuation; markings usually pinnate **Naviculeae.**  
 a Cell not wedge-shaped in either girdle or valve view. Valve straight or sigmoid; never crescent-shaped . **Naviculinae.**

- (i) Cells without internal compartments along the margins of the valves
    - (a) Valve without keel . . . . . **Naviculidae.**
      - \* Raphe straight or barely undulate, its tips turned toward the same side of the valve; outline of valve boat-shaped . . . . . **Naviculae.**  
(6) *Navicula* (p. 154)
      - \*\* Raphe strongly curved into an S, rarely into a C; sides of valves usually corresponding to the same curve. Tips of the raphe turned to opposite sides of the valve **Pleurosigmae.**  
(7) *Pleurosigma* (p. 155)
    - (b) Valve with keel. Raphe straight or sigmoid, median or not . . . . . **Amphiproridae.**  
(8) *Amphiprora* (p. 158)
  - (ii) Cell with internal compartments along the margin of the valve. Characters, except the lateral compartments, the same as in *Naviculae* . . . . . **Mastogloidae.**  
(9) *Mastogloia* (p. 159)
- b Cell wedge-shaped in the direction of the transverse axis. Valve more or less crescent-shaped . . . . . **Cymbellinae.**
- (i) Valve without transverse ribs, raphe evident.  
(10) *Amphora* (p. 160)
- 2 Valve apparently without raphe, which is obscured by the marginal keel. Each valve with a sagittal keel. Transverse section rhombic. Keel with punctation and canal raphe. Markings always transverse . . . . . **Nitzschieae.**
- (11) *Bacillaria* (p. 160)
  - (12) *Nitzschia* (p. 161)
- IV Raphe hidden in lateral winged keel . . . . . **Surirelloideae.**
- 1 Valve surface not undulated in a series of transverse depressions and elevations . . . . . **Surirelleae.**  
(13) *Surirella* (p. 163)  
(14) *Campylodiscus* (p. 164)

---

## BACILLARIALES

### CENTRICAЕ

#### (1) Genus **PARALIA** HEIBERG

Short cylindrical cells, constricted at each end, firmly united by valve surfaces into long straight chains. Valve surface with radial puncta. Regular coarse network of more or less hexagonal markings on cell wall.

1 *Paralia sulcata* (EHR.) CLEVE1838a, EHRENBURG, p. 176, Pl. 21, f. 5, *Gaillonella sulcata*.

1873b, CLEVE, p. 7.

Cell thick walled, disc-shaped or cylindrical, constricted at each end. Cells united by valve surfaces into long straight chains. One girdle band usually covering the halves of two cells. Only three or four chains observed.

Diameter, 12—34  $\mu$ .Fig. 1 Part of a chain. Diameter, 12  $\mu$ .  $\times$  1500.(2) Genus **STEPHANOPYXIS** EHRENBURG

Cells oval, oblong or nearly circular, with hexagonal areolations. Margins rounded, with a crown of stout spines which unite the cells into usually short chains. Girdle between two cells reaching from center to center, without intercalary bands.

1 *Stephanopyxis Palmeriana* (GREV.) GRUNOW1865a, GREVILLE, p. 2, Pl. 1, f. 9 *Creswellia Palmeriana*.

1884, GRUNOW, p. 38.

Cells cylindrical with flat or convex valves. Usually in short chains. Girdle between two cells reaching from center to center. Without intercalary bands. Spines in a concentric ring, numerous, enlarged at the base. Areolations hexagonal. Near valve margin areoles small, 7—9 in 10  $\mu$ ; 3—3½ in 10  $\mu$  near base of spines; 1½ in 10  $\mu$  in center of valve. Large areoles in center of valve more delicate, sometimes difficult to see. Fairly common.

Diameter, 93—105  $\mu$ .Fig. 2 Four cells in a chain, girdle view. Diameter, 105  $\mu$ .„ 2a Structure of the mantle.  $\times$  1500.„ 2b Structure of valve surface.  $\times$  750.(3) Genus **SKELETONEMA** GREVILLE

Cells circular, lens-shaped, oblong or cylindrical. Without distinct sculpture. At margin of valve a row of spines parallel to the longitudinal axis, which unite the cells into chains by interlocking.

1 *Skeletonema costatum* (GREV.) CLEVE1866, GREVILLE, p. 77, Pl. 8, f. 3-6. *Melosira costata*.

1878, CLEVE, p. 18.

Chains thin, usually straight. Cells lens-shaped, elliptical or

cylindrical, with rounded ends, joined into chains by long, straight, marginal spines parallel to the longitudinal axis. Space between cells usually longer than cells. Common.

Diameter, 8—14  $\mu$ .

Fig. 3 Part of a chain, girdle view. Diameter, 12  $\mu$ .  $\times$  1500.

„ 3a Valve view of a cell. Diameter, 12  $\mu$ .  $\times$  1500.

#### (4) Genus **COSCINOSIRA** GRAN

Cells short, usually disc-shaped, united in flexible chains by several threads coming from corresponding pores. Valves finely sculptured, with a central axis and marginal spinulae. Valves rounded or flat, sometimes depressed in the center. One or more intercalary bands.

##### 1 *Coscinosira Oestrupii* OSTENFELD.

1900, p. 52.

Cells cylindrical with nearly flat, slightly rounded, or occasionally concave valves. Distinct more or less irregular reticulations on valves. Marginal spinulae absent. Cells united into chains by numerous mucus threads either parallel to longitudinal axis or slightly bulged. Rare.

Diameter, 24—36  $\mu$ .

Fig. 4 Four cells in a chain, girdle view. Diameter, 24  $\mu$ .  $\times$  750.

#### (5) Genus **COSCINODISCUS** EHRENBURG

Cells simple discs, without large knobs or processes. Valve sculpture hexagonal meshes or fine round puncta, or areoles arranged in various ways. Marginal spinulae present or absent. Apicules present or absent. Girdle a single band to each valve, or with one or more collarlike intercalary bands.

The following groups given by GRAN are represented:

- Section I **Lineati**. Valves flat, usually with marginal spinulae. Areoles regular, hexagonal in straight or curved rows, not radiating from the center.
- Section II **Radiati**. Larger forms usually with strong valve structure. Areoles radiating from the center, not divided up into sectors. Central rosettes present or absent. Spinulae and apicules present or absent.
- Section III **Fasciculati**. Valves usually more or less flat. Spinulae and one or two apicules present or absent. Areoles in sectors; the sectors curved or straight.

##### Section I. — **Lineati**

##### 1 *Coscinodiscus excentricus* EHR.

1838b, p. 146.

Cell disc-shaped. Valves almost flat with narrow margins having

spinulae arranged in an irregular circle, 2—4 in 10  $\mu$ . Sculpture hexagonal meshes or areoles, arranged in slightly curved, nearly parallel rows, based on arrangement of seven. Meshes not radiating from the center. Usually a single central mesh with seven meshes around it. Areoles 5—6 in 10  $\mu$  in center, 8—9 in 10  $\mu$  near edge. Fine radial striae on valve margin, 14—18 striae in 10  $\mu$ . Common.

Diameter, 20—66  $\mu$ .

Fig. 5 Valve. Diameter, 32  $\mu$ .  $\times$  1500.

„ 5a Structure of valve.  $\times$  1500.

## 2 *Coscinodiscus lineatus* EHR.

1838b, p. 129.

Cells disc-shaped with almost flat, seldom slightly concave or convex valves. Valve margin narrow, with radial striae, 9—10 in 10  $\mu$ . Marginal spinulae present. Areoles hexagonal, in straight lines instead of curves, based on six sectors, slightly smaller at margin but of similar size over most of valve, 5—7 in 10  $\mu$ . Chamber openings in areoles mostly distinct. Not common.

Diameter, 56—89  $\mu$ .

Fig. 6 Valve. Diameter, 86  $\mu$ .  $\times$  750.

„ 6a Structure of valve.  $\times$  1500.

## Section II. — Radiati

### 3 *Coscinodiscus marginatus* EHR.

1839, p. 142.

Synonym: *Coscinodiscus subconcauus* GRUNOW forma major SCHMIDT Atlas, Pl. 62, f. 7.

Cell thick-walled, valves convex. Valves with large areoles in more or less regular, radial or parallel rows. Without central area or rosette. Areoles of nearly equal size, slightly smaller near margin, 3½—4 in 10  $\mu$ . Chamber openings distinct. Outer membrane with a ring of delicate puncta. Margin of valve wide, with heavy radial striae, 9—10 in 10  $\mu$ . Not common.

Diameter, 24—36  $\mu$ .

The individuals in this material correspond to Schmidt's figure and to the figure of *C. subconcauus* GRUN. in WOLLE (1894, Pl. 81, f. 10), rather than to figures of a typical *C. marginatus*.

Fig. 7 Valve. Diameter, 36  $\mu$ .  $\times$  1500.

„ 7a Structure of valve. Focus lower than in fig. 7.  $\times$  1500.

„ 7b Structure of valve. Focus above fig. 7.  $\times$  1500.

4 *Coscinodiscus radiatus* EHR.

1838b, p. 148, Pl. 3, f. 1 a-c.

Cell flat-disc-shaped with almost flat or very slightly curved valves. No spinulae or apicules. Sculpture coarse, no central rosette or area, meshes about the same size from center to margin, 3—4 in 10  $\mu$ ; slightly smaller at extreme edge, 6—8 in 10  $\mu$ . Chamber openings in areoles indistinct. Valve margin small, with radial striae, 6—8 in 10  $\mu$ . Rare.

Diameter, 73  $\mu$ .Fig. 8 Valve. Diameter, 73  $\mu$ .  $\times$  750.,, 8a Structure of margin of valve.  $\times$  1500.,, 8b Structure of margin of valve, showing network of areoles.  $\times$  1500.5 *Coscinodiscus nodulifer* SCHMIDT

1878, Atlas, Pl. 59, f. 20-23.

Cell disc-shaped with flat valves. Valves with more or less strong areoles, without rosette, frequently with a small central area. One more or less conspicuous nodule near the center of the cell. Areoles of nearly the same size over entire valve, 4—5 in 10  $\mu$ ; only near the edge and usually in the center slightly smaller. Chamber openings distinct. Outer membrane very delicately punctated. Arrangement of areoles irregular, radial rows inconspicuous, oblique decussating rows more distinct. Valve margin relatively wide, with strong radial striae, 6—8 in 10  $\mu$ . A row of very delicate spinulae on inner half of marginal region, difficult to see. Rare.

Diameter, 42  $\mu$ .Fig. 9 Valve. Diameter, 42  $\mu$ .  $\times$  1500.,, 9a Structure of valve showing areole network. Diameter, 42  $\mu$ .  $\times$  1500.6 *Coscinodiscus Jonesianus* (GREV.) OSTENFELD1862, GREVILLE, p. 22, Pl. 2. f. 3, *Eupodiscus Jonesianus*.

1915, OSTENFELD, p. 13. f. 7.

Cells large. Valves flat or concave in the center, sometimes slightly higher on one side than on the other. Areoles in the center in a more or less distinct rosette, usually prominent but sometimes absent altogether. 5—6 areoles in 10  $\mu$  near the center, further out 8—9 in 10  $\mu$ , near margin 13—15 in 10  $\mu$ . Outer membrane very delicately punctated. Radial rows and secondary spiral row regular. Interstitial meshes, possibly spinulae, sometimes present on valve surface forming an irregular



ring about half-way between center and margin. Inside the margin a row of distinct but small spinulae, 8—10  $\mu$  apart, from which fine radial hyaline ribs run toward the center. Radial ribs almost absent in some individuals. Areoles on each side of hyaline area somewhat larger than the others. Two extraordinarily large, cone-shaped processes near margin, situated at an angle of 110°—125° apart. Common.

Diameter, 260—430  $\mu$ .

- Fig. 10 Valve with processes and hyaline ribs.  $\times$  160.  
 „ 10a Center of valve without definite rosette.  $\times$  1500.  
 „ 10b Process.  $\times$  1500.  
 „ 10c Structure midway between center and margin of valve.  $\times$  1500.  
 „ 10d Structure of valve near margin showing process, spinulae and hyaline ribs.  $\times$  1500.  
 „ 10e Rosette. Puncta on outer membrane indicated.  $\times$  1500.  
 „ 10f Rosette of another valve.  $\times$  1500.

var. *commutata* (GRUN.) HUSTEDT

1884, GRUNOW, p. 79. *Eupodiscus* (?) *commutatus*, *Coscinodiscus commutatus*.

1928, HUSTEDT, p. 440, f. 240.

Cell medium-sized. Valves slightly convex. Sculpture coarse. Central rosette present, but less well differentiated than in *C. Jonesianus*, the areoles becoming smaller more gradually. 4—5 areoles in 10  $\mu$  near the center, 6 in 10  $\mu$  midway between center and margin, 8 in 10  $\mu$  near margin. Small marginal spinulae present, 8—10  $\mu$  apart, but with no hyaline ribs extending from them. Interstitial mesh absent. Two large conical processes very similar to those in the type, situated at an angle of 110°—120° apart. Not common.

Diameter, 81—134  $\mu$ .

- Fig. 11 Valve showing marginal spinulae and large processes.  
 Diameter, 134  $\mu$ .  $\times$  325.  
 „ 11a Center of valve.  $\times$  1500.  
 „ 11b Section of valve.  $\times$  750.  
 „ 11c Rosette showing net of areoles.  $\times$  1500.  
 „ 11d Process.  $\times$  1500.

7 *Coscinodiscus concinnus* W. SM.

1856, Syn. Vol. II, p. 85.

Cells large, drum-shaped with convex valves almost flat or slightly in-

dented in the center. Thin walled, hyaline in appearance. Sculpturing very fine, radial. Typical form with a rosette of large meshes. Rosette frequently completely absent, a large central area taking its place. Areoles 10—13 in  $10\ \mu$  near center, 11—14 in  $10\ \mu$  near margin. Chamber openings indistinct. Outer membrane very delicately punctated. Radial rows and secondary spiral rows regular. Inside the margin a row of distinct, but small spinulae about  $10\text{--}30\ \mu$  apart, from which more or less distinct, hyaline ribs run toward the center. Two small, asymmetrical processes or apicules clearly perceptible, at an angle of about  $120^\circ$  apart. Girdle with many intercalary bands. Cell very similar in shape to *C. nobilis*. Not common.

Diameter,  $300\text{--}310\ \mu$ .

Fig. 12 Valve showing marginal processes and spinulae with hyaline ribs. Diameter,  $301\ \mu$ .  $\times 325$ .

„ 12a Section of valve.  $\times 750$ .

„ 12b Center region.  $\times 1500$ .

„ 12c Outer region.  $\times 1500$ .

#### 8 *Coscinodiscus nobilis* GRUNOW

1879, p. 687, Pl. 21, f. 1.

Cells large, drum-shaped with convex valves almost flat or slightly indented in the center. Intercalary bands numerous, collar-shaped. Sculpturing fine, radial. Central space distinct, hyaline. Areoles 9—10 in  $10\ \mu$  near center; 6—7 in  $10\ \mu$  near margin and on larger part of valve, hexagonal toward the margin. Inside the margin a row of distinct but small spinulae, about  $7\text{--}12\ \mu$  apart, from which usually inconspicuous, radial, hyaline ribs run toward the center. Apparently irregularly placed spinulae on valve surface from which hyaline ribs also run toward the center. Two small but distinct apicules on the margin at an angle of about  $115^\circ$  to  $120^\circ$  apart. In general shape resembles *C. concinnus* closely, but sculpturing coarser and not hyaline in appearance. When dried, a dark fawn color similar to *Hemidiscus Hardmanianus*. Abundant in some catches.

Diameter,  $325\text{--}490\ \mu$ .

Fig. 13 Valve showing spinulae and hyaline ribs. Diameter,  $446\ \mu$ .  $\times 160$ .

„ 13a Center of valve. Diameter,  $314\ \mu$ .  $\times 1500$ .

„ 13b Structure of valve midway between center and margin.  $\times 1500$ .

- Fig. 13c Girdle view of a cell possibly after division. Diameter, 325  $\mu$ .  $\times$  170.  
 „ 13d Girdle view. Diameter, 400  $\mu$ .  $\times$  170.  
 „ 13e Section of a valve. Diameter, 314  $\mu$ .  $\times$  750.  
 „ 13f Structure of marginal region showing apicule and spinulae with hyaline ribs.  $\times$  1500.

9 *Coscinodiscus asteromphalus* EHR.

1844, p. 77.

Cell disc-shaped, valves depressed in the middle, convex on the margin. Valve surface radially areolated, with a large rosette and often a more or less large clear area in the center. Areoles polygonal, nearly the same size on entire valve, except somewhat smaller in marginal region. 3—5 in 10  $\mu$ . Chamber openings (central dots) distinct. Outer membrane strikingly punctated. Margin more or less wide, with radial striae, 5—6 in 10  $\mu$ . No spinulae visible in valve view. Not common.

Diameter, 245—363  $\mu$ .

- Fig. 14 Section of valve. Diameter, 281  $\mu$ .  $\times$  750.  
 „ 14a Structure midway between center and margin showing puncta on outer membrane.  $\times$  1500.  
 „ 14b Structure of marginal region.  $\times$  1500.  
 „ 14c Center of valve with puncta of outer membrane. Diameter, 342  $\mu$ .  $\times$  1500.

10 *Coscinodiscus oculus-iridis* EHR.

1838b, p. 147.

Cell disc-shaped. Center part of valve slightly concave. Areoles large, radiating from the center. Rosette usually large, sometimes with a small central hyaline area. In the region of the rosette, 4—5 areoles in 10  $\mu$ ; nearer the margin, 2½—3½ in 10  $\mu$ ; in the small marginal region, 5—6 in 10  $\mu$ . Chamber openings distinct. Margin small, with radial striae corresponding to the outer areoles, 6—8 in 10  $\mu$ . No marginal spinulae visible in valve view. Two asymmetrical processes, small, but usually clear. Rare.

Diameter, 135  $\mu$ .

- Fig. 15 Valve. Diameter, 135  $\mu$ .  $\times$  750.  
 „ 15a Center showing areole network.  $\times$  1500.  
 „ 15b Center showing chamber openings.  $\times$  1500.  
 „ 15c Section in marginal region.  $\times$  1500.

11 *Coscinodiscus gigas* EHRENBERG

1841, p. 412.

var. *praetexta* (JANISCH) HUSTEDT1891, JANISCH, *Coscinodiscus praetextus*, Pl. 3, f. 4.

1928, HUSTEDT, p. 457, f. 255, 256b.

Cell disc-shaped with almost flat valves. No rosette, central area large. Areoles on the outside near the margin small, 3—4 in 10  $\mu$ ; then large, 2 in 10  $\mu$ , and dark, forming a broad definite band 30—35  $\mu$  in width; toward the center more delicate and hyaline in appearance, 2½—3 in 10  $\mu$ ; at the center, 3—4 in 10  $\mu$ . Areoles rounded toward the center, then hexagonal. Chamber openings distinct only in the outer part of the valve. Outer membrane in marginal region delicately punctated; nearer the center puncta on only the margins of the areoles. Radial and secondary spiral rows very regular. Valve margin small, radially striated, striae 5—6 in 10  $\mu$ . Two asymmetrical processes, at an angle of about 120° apart, small but distinct. Very abundant in some samples.

Diameter, 391—575  $\mu$ .Fig. 16 Section of valve. Diameter, 551  $\mu$ .  $\times$  750.,, 16a Small section of center showing puncta on margin of areoles.  $\times$  1500.,, 16b Section of marginal region showing areole network. Puncta of outer membrane indicated.  $\times$  1500.12 *Coscinodiscus Janischii* A. SCHMIDT

1878, Atlas, Pl. 64, f. 3, 4.

var. *arafurensis* GRUNOW

1884, p. 76.

Cell disc-shaped, with almost flat valves, slightly depressed in the center. Central area small but distinct. A row of small areoles near the margin, about 4 in 10  $\mu$ ; around the central area 2½ to 3 in 10  $\mu$ ; on rest of surface of valve of nearly equal size, about 2 in 10  $\mu$ . Valve hyaline in appearance. Radial and secondary spiral rows distinct. Valve margin small, with radial striae, about 5—6 in 10  $\mu$ . Rare.

Diameter, 170—261  $\mu$ .

Except for the larger size of the areoles, the cells observed in this material resemble those figured by JANISCH in "The Diatoms of the Gazelle Expedition", Plate 4, figures 3 and 5 as *C. arafurensis*. RATTRAY

(1889, page 543) gives *C. arafurensis* as a synonym of *C. Janischii*. *C. Janischii* has about 3—4 areoles in  $10\ \mu$  on the larger part of the valve, while its variety has about 2 in  $10\ \mu$ .

Fig. 17 Valve. Diameter,  $175\ \mu$ .  $\times 325$ .

„ 17a Section of valve.  $\times 750$ .

„ 17b Section of marginal region.  $\times 1500$ .

„ 17c Margin.  $\times 1500$ .

„ 17d Center.  $\times 1500$ .

### Section III. — Fasciculati

#### 13 *Coscinodiscus subtilis* EHR.

1841, p. 412, Pl. I, III, f. 18; Pl. 3, VII, f. 4.

Valves thin, with fine sculpture. 9—14 bundles of meshes or areoles running out from the center, 14—18 parallel rows in a bundle; oblique rays crossing the radial rays. Areoles gradually becoming smaller from the center toward the margin, 7—8 in  $10\ \mu$  near the center, 9 in  $10\ \mu$  near the margin, very fine in the margin. Marginal spinulae present, corresponding to the bundles. Given in HUSTEDT, 1928, as *C. excentricus* var. *fasciculata* HUSTEDT. Not common.

Diameter, 48—89  $\mu$ .

Fig. 18 Valve, half showing structure, half indicating arrangement of bundles of meshes. Diameter, 48  $\mu$ .  $\times 1500$ .

#### (6) Genus PLANKTONIELLA SCHÜTT

Cells single, disc-shaped, with a wing-like expansion all around, of extra-cellular chambers strengthened by radial rays.

##### 1 *Planktoniella sol* (WALLICH) SCHÜTT.

1860, *Coscinodiscus sol*, (WALLICH) p. 38, Pl. 2, f. 12.

1893a, Schütt, p. 20, f. 8.

Valves flat, disc-shaped, sculpture like *Coscinodiscus excentricus*. 5—6 areoles in  $10\ \mu$  near center of valve, 8—9 in  $10\ \mu$  near edge. Wing-like expansion all around cell, of extra-cellular chambers strengthened by radial rays. Rare.

Diameter, without border, 40—54  $\mu$ ; with border, 105—120  $\mu$ .

Fig. 19 Valve. Diameter, center, 40  $\mu$ ; whole valve, 105  $\mu$ .  $\times 750$ .

#### (7) Genus ACTINOPTYCHUS EHRENBERG

Cells single, disc-shaped. Valve divided into sectors alternately raised and depressed. Smooth central field.

1 *Actinoptychus undulatus* (BAIL.) RALFS1842, BAILEY, *Actinocyclus undulatus*.

1861, RALFS, in PRITCHARD, p. 839, Pl. 5, f. 88.

Cell disc-shaped, with strongly undulating valves. Valves with usually six sectors of similar size. Central area smooth, hexagonal. The raised sectors with a short, blunt process in the middle of the outer margin; surface strongly areolated and punctated. Areoles 4—6 in  $10\ \mu$ , more or less regular. Puncta in radial and oblique rows diverging slightly as they approach the center, about 18—19 in  $10\ \mu$ . The depressed sectors usually without processes. Areoles less prominent than in raised sectors but similarly arranged. Punctation coarser, radial rows less distinct, oblique rows stronger, about 12—15 in  $10\ \mu$ . Cell wall strong. Rare.

Diameter, 36—48  $\mu$ .Fig. 20 Valve. Diameter, 48  $\mu$ .  $\times$  1500.(8) Genus **ASTEROLAMPRA** EHRENBERG

Cell disc-shaped, sharply divided into sectors by broad hyaline rays running from the hyaline center toward the margin. Rays all of same width and generally tapering to the margin, outer ends with a minute spine. Hyaline center divided into more or less wedge-shaped divisions. Fine areolation between rays. Central area either reticulated or divided by straight lines into the same number of parts as the rays.

1 *Asterolampra marylandica* EHR.

1844, p. 76, f. 10.

Cell disc-shaped. Valve with large, hyaline middle region, at least one-third diameter of valve, divided into 7 sectors. Seven narrow, hyaline rays of like size and structure from central region almost to edge of valve, with a short process on the outer end. Segments between rays regularly areolated, with areoles in a three-line system. About 13 areoles in  $10\ \mu$ , larger on the border of the segments along the rays. Rare.

Diameter, 70  $\mu$ .

Fig. 21 Valve. Structure of segments indicated on one segment.

Diameter, 70  $\mu$ .  $\times$  750.(9) Genus **ASTEROMPHALUS** EHRENBERG

Cells single, disc-shaped or ovate. Valves flat, areolated. Central field smooth with only a few lines, from which a number of smooth rays run. One of the radiating rays narrower than the others; rays not tapering to the margin; central area never reticulated; unequally divided into the same number of parts as the rays by more or less zigzag lines.

1 *Asteromphalus flabellatus* (BRÉB.) GREVILLE1857, BRÉBISSE, p. 297, Pl. 3, f. 3, *Spantangidium flabellatum*.

1859, GREVILLE, p. 160, Pl. 7, f. 4, 5.

Cell ovate. Middle hyaline area excentric, about half the diameter of the cell. Sector lines of middle area not branched. Eight slender hyaline rays, one much thinner than other seven, from center area almost to margin of cell. Rays straight or slightly curved. Segments eight, clearly but delicately areolated. Areoles about 16 in  $10\ \mu$ , larger around inner border, finer toward outside margin of segments; arranged in a three line system. Rare.

Length: long axis,  $42\ \mu$ ; short axis,  $24\ \mu$ .Fig. 22 Valve. Length, long axis,  $42\ \mu$ ; short axis,  $24\ \mu$ .  $\times 1500$ .2 *Asteromphalus Cleveanus* GRUNOW(= *A. Wallichianus* CLEVE not Grev.) Figure in SCHMIDT, Atlas Heft 10. Pl. 38, f. 13, 14.

1873a, CLEVE, p. 5, Pl. 1, f. 1.

General appearance of cell similar to that of *A. flabellatus*. Cell ovate. Hyaline central area about half diameter of cell. Sector lines of central area straight or branched. Ten slender, hyaline rays, one much thinner than others, straight or slightly curved. Segments ten, with areolation closely resembling that of *A. flabellatus*, 16 in  $10\ \mu$ . Identification not entirely satisfactory, may be a form of *A. flabellatus*. Rare.

Length: long axis,  $70\ \mu$ ; short axis,  $40\ \mu$ .Fig. 23 Valve. Length, long axis,  $70\ \mu$ ; short axis,  $40\ \mu$ .  $\times 750$ .

## (10) Genus CORETHRON CASTRACANE

Cells living singly, cylindrical with rounded valves, which bear at the margin a crown of long thin spines directed outward at an angle. Numerous intercalary bands, scale-like and very indistinct.

1 *Corethron criophilum* CASTR.

1886, p. 85, Pl. 21, f. 12, 14, 15.

Cells living singly, cylindrical with round valves at the margin of which is a crown of long thin spines directed outwards at an angle, those of the two valves directed in the same direction. Not common.

Diameter,  $18-48\ \mu$ .Fig. 24 Girdle view. Diameter,  $18\ \mu$ .  $\times 750$ .,, 24a Girdle view of another cell. Diameter,  $48\ \mu$ .  $\times 750$ .

(11) Genus **LAUDERIA** CLEVE

Cells shortly cylindrical, united in straight chains by very fine slime threads, the cells either touching or separated. Valve with an unpaired apicule and numerous very small spinulae at the margin and over the valve surface. Center of valve slightly depressed. Intercalary bands numerous, collar-shaped, more or less conspicuous.

1 *Lauderia annulata* CLEVE

1873a, p. 8, Pl. 1, f. 7.

Cells cylindrical. Valves slightly convex, with a slight depression in the middle. United into straight, thick chains with the elevated portions of the valves usually touching. Valves with numerous small spines or slime threads, some long, others short, the longer ones running between cells uniting them into chains. Intercalary bands numerous, collar-shaped. Surface of cell delicately punctated. Puncta more or less irregular, 13—14 in  $10\ \mu$ , sometimes in a two line system. This species more robust than *L. borealis*, especially the intercalary bands and spines or slime threads. An inhabitant of warmer seas. Common.

Diameter, 18—52  $\mu$ ; length along perivalval axis, 34—79  $\mu$ .

Fig. 25 Four cells in a chain, girdle view. Diameter, 48  $\mu$ .  $\times$  325.

„ 25a Cell more highly magnified.  $\times$  750.

„ 25b Chain of two cells. Diameter, 42  $\mu$ .  $\times$  325.

„ 25c Part of cell in girdle view enlarged to show puncta.  $\times$  1500.

(12) Genus **SCHRÖDERELLA** PAVILLARD

Cells cylindrical, forming straight chains. Sometimes single. Valve flat or slightly convex, but depressed in the center. Distinct spine in center unites neighbouring cells. Margin surrounded by a row of small spinulae, from each of which arise two gelatinous threads, which diverge and join the corresponding thread, forming a characteristic zigzag. Threads may sometimes appear straight. Intercalary bands numerous, forming incomplete hoops. Punctuation on bands minute.

1 *Schröderella delicatula* (PÉRAG.) PAVILLARD.

1888, PÉRAGALLO, *Lauderia delicatula* PÉRAG. p. 81, Pl. 6, f. 46.

1913, PAVILLARD, p. 126.

Cells cylindrical, longer than broad. Valves more or less convex, occasionally almost flat, always, however, depressed in the center. Chains



straight, more or less stiff. Intercalary bands collar-like, of varying numbers. Margin of valve surrounded by a row of small spinulae, from each of which two gelatinous threads arise, diverge, and join the corresponding thread of the adjoining cell to form a characteristic zigzag. In the center of each valve, in the depression, is a distinct spine which joins the spine of the neighbouring cell. Delicate areolation, about 18—20 areoles in  $10\ \mu$ , arranged in a two line system with the lines crossing each other. Fairly common.

Diameter,  $18\ \mu$ ; length along perivalval axis,  $40\ \mu$ .

Fig. 26 Girdle view. Sculpturing of bands indicated. Diameter,  $18\ \mu$ .  $\times 1500$ .

„ 26a Spine running between adjacent cells. Optical view.  $\times 1500$ .

### (13) Genus *LEPTOCYLINDRUS* CLEVE

Cells long and cylindrical, united into chains by whole valve surface. Valves flat, unarmed. Intercalary bands very difficult to be seen, not spiral.

#### 1 *Leptocylindrus danicus* CLEVE.

1889, p. 15, Pl. 2, f. 4, 5.

Cells long, cylindrical, three times longer than broad, united by whole valve surface into long stiff chains. Valves flat or convex, occasionally concave, without visible sculpturing. Intercalary bands not seen in water mounts. Rare.

Diameter,  $8\ \mu$ .

Fig. 27 Two cells in a chain. Drawn from a water mount. Diameter,  $8\ \mu$ .  $\times 750$ .

### (14) Genus *GUINARDIA* H. PÉRAGALLO

Cells cylindrical, longer than broad, living singly or united in chains by whole flat valve surface. At the valve margin an asymmetrical lateral tooth. Intercalary bands numerous, collar-like.

#### 1 *Guinardia flaccida* (CASTR.) PÉRAGALLO.

1886, CASTRACANE, *Rhizolenia* (?) *flaccida* CASTR. p. 74 Pl. 29, f. 4.

1892, PÉRAGALLO, p. 107, Pl. 13, f. 3, 4.

Cells typically cylindrical,  $1\frac{1}{2}$  to several times longer than broad, single or united in chains by whole valve surface. Valve almost flat or

slightly concave with a slight wave on the margin and a scarcely visible rudimentary point. Intercalary bands numerous, collar-like, their ends lying spirally around the cell. Cell-wall weakly siliceous, falling together when dried. No visible sculpturing on bands; very delicate, fine punctation on valve, in rows 21—23 in  $10\ \mu$ . Fairly common.

Diameter, 42—110  $\mu$ .

Fig. 28 Girdle view. Diameter, 42  $\mu$ .  $\times$  750.

„ 28a Dried specimen with deflated appearance. Diameter, 87  $\mu$ .  
 $\times$  325.

### (15) Genus RHIZOLENIA (EHRENBERG) BRIGHTWELL

Cells cylindrical, straight, or more rarely curved, living singly or in chains. Valve with an excentric apex or with an excentric fine hair-like spine or process. Girdle zone with numerous intercalary bands of different forms and arrangements in different species.

The following divisions of the genus are based on those of GRAN (1905):

Section I Annulosolenia. Intercalary bands annular (collar-shaped).

Sub-section 1 Lauderioideae. Valves rounded, with spine or bristle.

2 Robustae. Valves cone-shaped, elongated, with spine.

Section II Eusolenia. Intercalary bands scale-like, in two or more rows. Valve cone-shaped with excentric point or spine.

Sub-section 1 Squamosae. Intercalary bands in four or more rows. Warm water forms.

2 Imbricatae. Intercalary bands in two lateral rows with the middle line in the transapical plane. (Sutures dorsi-ventral in a zigzag).

3 Neriticae. Intercalary bands in two dorsi-ventral rows, but the middle line in the apical axis (Lines of suture a zigzag). Process solid.

4 Styliformes. Intercalary bands as in 3. Process with cavity at the base.

5 Alatae. Intercalary bands as in 3 and 4. Valves without true spine or terminal process, only drawn out cone-shaped and with an impression of the neighbouring cell or a depression into which its apex fits.

## Section I. — Annulosolenia

Sub-Section 1. — *Lauderioideae*1 *Rhizosolenia Stolterfothii* H. PÉRAGALLO

1888, p. 82, Pl. 6, f. 44.

Cell cylindrical. Small excentric spine fits into depression of adjoining cell, thus binding cells into curved, often spiral chains. Valves flat, rounded at the ends. Intercalary bands ring-shaped or collar-like, numerous, not always easily seen. No sculpturing on valves or bands visible. Common.

Diameter, 18—44  $\mu$ ; length to 260  $\mu$ .Fig. 29 Two cells in a chain. Length, 260  $\mu$ ; diameter, 18  $\mu$ .  
× 325.,, 29a Length, 196  $\mu$ ; diameter, 44  $\mu$ . × 325.2 *Rhizosolenia cylindrus* CLEVE.

1897, p. 24, Pl. 2, f 12.

Cell cylindrical in shape with convex or conical valves. Cells united in chains by comparatively large, curved process present on each valve. Numerous ring-shaped intercalary bands. Cell-wall thin, without perceptible fine sculpturing. Very rare, only two specimens observed.

Diameter, 24  $\mu$ ; length, 98  $\mu$ .Fig. 30 Length, 98  $\mu$ ; diameter, 24  $\mu$ . × 750.Sub-Section 2. — *Robustae*3 *Rhizosolenia robusta* NORMAN1861 in PRITCHARD, *Infus.*, p. 866, Pl. 8, f 42.

Cell cylindrical in central region, with deeply convex or conical curved valves. Intercalary bands robust, numerous, typically collar-shaped. Short spine set in small, hollow, apical process of valve. Cell-wall thin. Punctuation fine, irregular near point, in regular lines on greater part of valve, about 20 lines in 10  $\mu$ ; slightly finer on intercalary bands, but likewise in regular lines. Not common.

Diameter, 75—97  $\mu$ .Fig. 31 End of a typical cell. Diameter, 87  $\mu$ . × 160.,, 31a End of valve showing base of spine. Punctuation indicated.  
× 1500.

,, 31b Spine. × 1500.

,, 31c Punctuation on valve. × 1500.

## Section II. — Eusolenia

## Sub-Section 1. — Squamosae

4 *Rhizosolenia Bergonii* H. PÉRAGALLO

1892, p. 110, Pl. 15, f 5.

Synonym: — *R. amputata* OSTENFELD, 1902, p. 227, f. 4.

Cell with cylindrical central region, elongated cone-shaped valves. Intercalary bands scale-like, in 4 or 5 rows, imbrication lines clear. Apical process, short, straight, centrally located, traversed by canal in center, cut off abruptly at end. Canal enlarged at base, bell-shaped at apex. Walls of valve near apex thickened. Punctuation coarse near apex, puncta in lines converging toward base of valve, 18 puncta in 10  $\mu$ ; near base of valve, 20—22 in 10  $\mu$ . Walls of intercalary bands more delicate, punctuation finer, 24 in 10  $\mu$ . Not common.

Diameter, 34—36  $\mu$ .Fig. 32 Diameter, 34  $\mu$   $\times$  750.,, 32a Punctuation on valve and intercalary band.  $\times$  1500.,, 32b End of valve and apical process.  $\times$  1500.5 *Rhizosolenia arafurensis* CASTRACANE

1886, p. 74, Pl. 30, f. 12.

Cell cylindrical, valve conical with hollow, tubular process abruptly truncated at apex. Intercalary bands in several rows, scale-like, rhombic with wavy margins. Cell-wall thin. No sculpturing visible in specimens observed. Rare.

Diameter, 65—94  $\mu$ .Fig. 33 Diameter, 94  $\mu$ .  $\times$  325.6 *Rhizosolenia Clevei* OSTENFELD

1902, f. 6.

Cells large, valves rounded convex. Intercalary bands numerous imbricated scales, 5 to 8 in circumference. Apical process similar to that in *R. styliformis*, slightly curved, wings at base less prominent. No sculpturing visible. Not common.

Diameter, 36—85  $\mu$ ; length, 275—404  $\mu$ .Fig. 34 Length, 275  $\mu$ ; diameter, 61  $\mu$ .  $\times$  325.,, 34a Diameter, 85  $\mu$ .  $\times$  325.,, 34b Apical process.  $\times$  1500.

Sub-Section 2. — *Imbricatae*7 *Rhizosolenia imbricata* BRIGHTWELL

1858, p. 95. Pl. 5, f. 6.

Cell cylindrical. Intercalary bands scale-like, numerous, in two long rows. Apical process short and straight, in lateral view abruptly diminished from a slightly enlarged base, in dorsal view wide wedge-shaped, only gradually diminished with two small lateral wings at the base. Cell-wall strong and clearly sculptured. Striations on intercalary bands, coarse, running from center line fan-like to sides, 10—13 lines with 18—20 puncta in 10  $\mu$ , on girdle bands and valves finer, not fan-like. Common.

Diameter, 30—73  $\mu$ .Fig. 35 Diameter, 48  $\mu$ .  $\times$  750.„ 35a Punctuation on intercalary band.  $\times$  1500.„ 35b Diameter, 36  $\mu$ .  $\times$  750.„ 35c Two cells united. Diameter, 30  $\mu$ .  $\times$  750.var. *Shrubsolei* (CLEVE) SCHRÖDER

1881, CLEVE, p. 26.

1906, SCHRÖDER, p. 346.

Cell long, narrow, cylindrical. Valves oblique. Intercalary bands scale-like, striations formed of rows of minute puncta, 22 in 10  $\mu$ . Bands in two long rows. Differentiated from type by smaller diameter, more elongated valve and finer sculpturing. Apical process likewise with very small wings at base. Fairly common.

Diameter, 18—20  $\mu$ .Fig. 36 Diameter, 18  $\mu$ .  $\times$  1500.„ 36a Same cell.  $\times$  750.Sub-Section 3. — *Neriticae*8 *Rhizosolenia setigera* BRIGHTWELL

1858, p. 95, Pl. 5, f. 7.

Cell rod-like, cylindrical. Valves conical, slightly oblique. Apical process cylindrical, thickened for some distance from base with a very fine canal in the center, then suddenly diminished to end in a long, fine spine. Intercalary bands scale-like, two long rows pointing toward apex. No visible punctuation. Common.

Diameter, 10—42  $\mu$ .Fig. 37 Diameter, 16  $\mu$ .  $\times$  750.„ 37a „ 12  $\mu$ .  $\times$  750.

## Sub-Section 4. — Styliformes

9 *Rhizosolenia styliformis* BRIGHTWELL

1858, Pl. 5, f. 5a—d.

Cell cylindrical with two rows of dorso-ventral scale-like intercalary bands. Valve sharply cone-shaped. Apical process short, hollow at base, with two lateral wings. Cell-wall thin with clear sculpturing. Punctuation: rows of puncta 28—30 in 10  $\mu$  near apex; 18—20 in 10  $\mu$  on intercalary bands. Not common.

Diameter, 61—80  $\mu$ .Fig. 38 Diameter, 80  $\mu$ .  $\times$  325.,, 38a Diameter, 66  $\mu$ .  $\times$  325.,, 38b Apical process.  $\times$  1500.var. *longispina* HUSTEDT

1914, in A. SCHMIDT, Atlas, Plate 316, f. 5—7, 12.

Differentiated from the type by longer apical process ending in a long spine. Striation clear, 17—18 puncta in 10  $\mu$  on intercalary bands, finer on valves. The alga *Richelia intercellularis* usually present in or on the cells. Common.

Diameter, 30—48  $\mu$ .Fig. 39 Diameter, 30  $\mu$ .  $\times$  750.,, 39a Punctuation on intercalary band.  $\times$  1500.,, 39b Diameter, 48  $\mu$ . Note *Richelia intercellularis*.  $\times$  325.var. *latissima* BRIGHTWELL

1858, Pl. 5, f. 5e.

Diameter greater than in type, 97—123  $\mu$ . Intercalary bands flatter. Cell-wall less heavily silicified. Punctuation not clear in specimens observed. Not common.

Fig. 40 Diameter, 123  $\mu$ .  $\times$  325.,, 40a ,, 123  $\mu$ .  $\times$  325.10 *Rhizosolenia calcar-avis* M. SCHULTZE

1858, p. 339, Pl. 13, f. 5—10.

Cell cylindrical, valves conical, curved at the apex. No wings on curved apical process. Intercalary bands scale-like, rhombic. Cell-wall thin. Punctuation difficult to see, about 18—20 lines in 10  $\mu$ . Common.

Diameter, 20—45  $\mu$ .Fig. 41 Diameter, 36  $\mu$ .  $\times$  750.,, 41a Punctuation on intercalary band.  $\times$  1500.,, 41b Diameter, 30  $\mu$ .  $\times$  325.

11 *Rhizosolenia hebetata* (BAIL.) GRAN. emend.

1856, BAILEY.

1904, GRAN, p. 524—527.

form *semispina* (HENSEN) GRAN.

1887, HENSEN, p. 84, Pl. 5, f. 39.

1904, GRAN.

Longitudinally drawn out valve with process thickened and hollow at base and ending in a long curved hair-like spine. Intercalary bands scale-like, in two long rows pointing toward apex. No perceptible sculpturing. Common.

Diameter, 12—16  $\mu$ .Fig. 42 Diameter, 16  $\mu$ .  $\times$  750.,, 42a ,, 16  $\mu$ .  $\times$  750.Sub-Section 5. — *Alatae*12 *Rhizosolenia alata* BRIGHTWELL

1858, p. 96, Pl. 5, f. 8.

Cell rod-shaped, cylindrical. Valves shortly conical ending in tube-like, more or less curved oblique process. Depression at base of tube into which apex of adjoining cell fits. Intercalary bands scale-like, rhombic, in two dorsi-ventral rows. No sculpturing visible in specimens observed. Common. Three forms or varieties as recognized by GRAN (1905) observed:

(a) Form *genuina* GRAN, 1905, p. 56, f. 68c.

Apex almost parallel with long axis of cell, slightly bent.  
Common.

Diameter, 18—24  $\mu$ .Fig. 43 *a, b* Diameter, 20  $\mu$ .  $\times$  750.,, 43 *c, d* Spores. Diameter, 24  $\mu$ .  $\times$  325.(b) Form *gracillima* (CLEVE) GRUNOW in V. H. Syn., Pl. 79, f. 8.

1881, CLEVE (as var.), p. 26, Pl. 6, f. 78.

Similar to the type, but narrower. Not common.

Diameter, 5—7  $\mu$ .Fig. 44 Diameter, 5  $\mu$ .  $\times$  750.(c) Form *indica* (PÉRAGALLO) OSTENFELD

1892, PÉRAGALLO, p. 116, Pl. 18, f. 16.

1901, OSTENFELD and SCHMIDT, p. 160.

Cell much larger and broader than the type. Process of valve curved, thin. Diameter 34—73  $\mu$ . Regarded as a distinct species by PAVILLARD (1925) and others. Common.

Fig. 45 Diameter, 36  $\mu$   $\times$  750.,, 45a Diameter, 46  $\mu$ .  $\times$  750.

(16) Genus **BACTERIASTRUM** SHADBOLT

Cells cylindrical. Valves with several regularly-arranged marginal bristles, by the fusion of which the cells are united into chains. The bristles of two neighbouring cells are fused for a longer or shorter distance outside the base, then separate further out. End bristles different from the others, often curved, not fusing with other bristles and consequently in valve view not bifurcating.

The following division of the genus is based on the different types of terminal setae or valves:

Section I **Isomorpha**. Setae of both terminal valves of a chain the same, all directed toward or all away from the chain axis.

Section II **Sagittata**. Chains with asymmetrical terminal valves which differentiate the ends of the chain into posterior and anterior ends.

Section I. — **Isomorpha**1 *Bacteriastrum delicatulum* CLEVE

1897, p. 298, f. 15.

Cells longer than thick. Setae about 7 to 10, perpendicular to chain axis; basal part long. Apertures large. Terminal setae bent over chain. Common.

Diameter, 6—16  $\mu$ .

Fig. 46 Part of a chain with terminal cell. Diameter, 12  $\mu$ .  $\times$  750.

„ 46a Part of a chain. Diameter, 6  $\mu$ .  $\times$  750.

„ 46b Valve view of terminal cell. Diameter, 10  $\mu$ .  $\times$  750.

„ 46c Valve view of inner cell. Diameter, 7  $\mu$ .  $\times$  750.

2 *Bacteriastrum hyalinum* LAUDER

1864, p. 6, Pl. 3, f. 7.

Cell usually flat, wider than long. Setae numerous, 24 to 33; basal part very short; bifurcations parallel to chain axis giving cells a hairy appearance. Terminal setae bent over chain axis and in toward it. Fairly common.

Diameter, 24—36  $\mu$ .

Fig. 47 Part of a chain with terminal cell. Diameter, 36  $\mu$ .  $\times$  325.

„ 47a Part of the center of a chain. Diameter, 24  $\mu$ .  $\times$  750.

„ 47b Valve view of terminal cell. 24 setae. Diameter, 36  $\mu$ .  $\times$  325.

„ 47c Valve view of an inner cell. 33 setae. Diameter, 24  $\mu$ .  $\times$  750.



3 *Bacteriastrum varians* LAUDER

1864, p. 8, Pl. 3, f. 1-6.

Cell of nearly equal width and length. Setae, 10 to 26, at right angles to chain axis; basal part usually shorter than in *B. delicatum*. Apertures small. Terminal setae with fine little spines arranged in spiral rows. Common.

Diameter, 30—36  $\mu$ .Fig. 48, 48a Parts of two chains. Diameter, 48, 30  $\mu$ ; 48a, 32  $\mu$ .

× 325.

,, 48b Two terminal setae. × 750.

,, 48c Valve view of an inner cell. Diameter, 34  $\mu$ . × 325.,, 48d, e Valve views of two terminal cells. Diameters, 30  $\mu$ .

× 325.

var. *hispida* (CASTR.) SCHRÖDER1886, CASTRACANE, p. 83, Pl. 29, f. 6. *B. Wallichii* PALFS, var. *hispida*  
1906, SCHRÖDER, p. 347, f. 11.

Terminal setae, usually 8, with large spirally arranged spines on basal part, smaller spines beyond bend toward end. Entire frustule or chain not observed. Not common.

Diameter, 18—20  $\mu$ .Fig. 49 End valve of a chain showing terminal setae. Diameter,  
18  $\mu$ . × 750.

,, 49a A single seta. × 750.

## Section II. — Sagittata

4 *Bacteriastrum comosum* PAVILLARD

1916, p. 29, Pl. 1, f. 3.

Cells much longer than broad. Apertures more or less large. Inner setae with short basal part perpendicular to chain axis; at bifurcation bent toward posterior end of chain and almost parallel with axis. Anterior terminal setae curved and directed toward posterior, with small spirally arranged spines. Posterior terminal setae thicker than the others; with spirally arranged spines; bent away from chains or in same direction as all other setae; usually converge slightly near ends. Setae 6 to 8. End valves of both posterior and anterior cells of the chain with a deep furrow. Fairly common.

Diameter, 7—10  $\mu$ .

- Fig. 50 Part of a chain with posterior terminal cell: Diameter, 8  $\mu$ .  $\times$  750.  
 „ 50a Part of a chain with anterior terminal valve. Diameter, 7  $\mu$ .  $\times$  750.  
 „ 50b Valve view with terminal setae shown by solid lines, inner setae by dotted lines. Diameter, 10  $\mu$ .  $\times$  750.

(17) Genus **CHAETOCERAS** EHRENBERG

Cells with oval section, sometimes nearly, rarely completely, circular; in girdle view quadrangular with straight sides and concave, flat, or weakly convex ends. Valve with a more or less flat end surface and a cylindrical part or valve mantle, which are bound together without a seam. A long thick or thin seta (also called bristle or awn) at each end of the long axis of the valve on the corners. The opposite setae of neighbouring cells touch one another near their origin, usually directly or sometimes by a bridge, firmly fused. By this fusion the cells are united into chains, usually with large or small apertures or foramina between the cells. Special terminal setae in some species, often shorter and thicker and more nearly parallel with the chain axis than the others. Cell-wall formed of two valves and one or two girdle bands. Intercalary bands present in some species, usually difficult to see without special preparations.

The following divisions of the genus are represented:

- Sub-genus I **Phaeoceras**. With numerous chromatophores which penetrate into the setae.  
 Section 1 **Borealia**. Bristles usually diverging in all directions, the direction on one valve often differing from that on the other. Usually no spine in the center of the valve.
- Sub-genus II **Hyalochaete**. Setae thin, without chromatophores in them.  
 Section 1 **Dicladia**. Setae not always coalesced for a portion of their length.  
 Section 2 **Cylindrica**. Valve nearly circular; apertures very narrow. Terminal setae not thicker than the others.  
 Section 3 **Compressa**. Cells compressed. Intercalary bristles thickened and twisted, sometimes occurring in between the normal bristles.  
 Section 4 **Protuberantia**. With a protuberance in the middle of the valve surface.  
 Section 5 **Constricta**. Cells more or less constricted. Girdle at least one-third of the length of the cell, terminal setae mostly thicker than the others.  
 Section 6 **Stenocincta**. Girdle narrow, not one-third of the length of the cell, Aperture rather narrow. Terminal setae thicker than the others, curved, and for the most part diverging greatly.

Section 7 *Laciniosa*. Girdle rather long. Aperture large, terminal setae mostly thicker than the others, not greatly diverging.

Section 8 *Diversa*. Short, rigid chains, end setae less spread out than a special pair of setae in the middle of the chain.

Section 9 *Curviseta*. Setae curved, all bent in one direction. Chains usually curved, without special end cells.

### Sub-genus I. — *Phaeoceras*

#### Section 1. — *Borealia*

##### 1 *Chaetoceras Eibenii* GRUNOW

1881, V. H. Syn., Pl. 82, f. 9, 10.

Straight chains. Apertures wide, six-sided, elliptical. Tiny spine in center of valve, not always visible in girdle view. Intercalary bands, collar-like, not present in all specimens observed. Setae striated, 23 rows in  $10\ \mu$ , arising from inner valve surface, with short basal region. Rare.  $36\ \mu$  broad.

Fig. 51 Part of a chain in broad girdle view. Intercalary bands not visible. Breadth,  $36\ \mu$ .  $\times 750$ .

„ 51a Part of a chain in broad girdle view, showing intercalary bands. Breadth,  $36\ \mu$ .  $\times 750$ .

##### 2 *Chaetoceras coarctatum* LAUDER.

1864, p. 79, Pl. 8, f. 8.

Chain straight, two ends different. Apertures very small. Posterior terminal setae large, strongly curved, heavily spined; anterior terminal setae less robust, curved toward posterior end, spined less heavily; setae in center of chain curved as anterior terminal setae, smaller spines, frequently with a species of *Vorticella* attached. Common.

$26\text{--}44\ \mu$  broad.

Fig. 52 Anterior end of a chain. Breadth,  $44\ \mu$ .  $\times 325$ .

„ 52a Posterior end of a chain. Breadth,  $26\ \mu$ .  $\times 325$ .

„ 52b Part of a chain in broad girdle view. Breadth,  $32\ \mu$ .  $\times 750$ .

„ 52c, d Parts of a center seta.  $\times 1500$ .

„ 52e, f Parts of a posterior seta.  $\times 1500$ .

##### 3 *Chaetoceras denticulatum* LAUDER.

1864, p. 79, Pl. 8, f. 9.

Chains straight, cells cylindrical. Apertures small, vertically rhombic. Base of setae longer than in *C. nanodenticulatum*, directed almost vertic-

ally, in *C. nanodenticulatum* diagonally. Usually a small process or tooth on inner side of setae, possibly for articulation with adjoining cell. Setae spinous and striated. Small spine in center of valve. Not common.

Breadth of cell, 24—30  $\mu$ .

Fig. 53 Part of a chain. Breadth, 28  $\mu$ .  $\times$  750.

„ 53a Single cell. Breadth, 30  $\mu$ .  $\times$  750.

„ 53b Part of a seta from cell shown in 53a.  $\times$  750.

„ 53c, d. Parts of a seta showing striae.  $\times$  1500.

#### 4 *Chaetoceras nanodenticulatum* OKAMURA

1907, p. 11, text fig. a—c.

Chain of few cells, straight, not twisted. Apical axis longer than chain axis of cell. Aperture elliptic-lanceolate. Setae arise within the corners, short base directed diagonally outward, straight in remaining part, striated. Resembles *C. boreale* BAIL. except for presence of teeth on posterior setae of each cell. Distinguished from *C. denticulatum* LAUDER by form and size of cell and aperture, direction and length of setae bases. Rare. Resembles the figures of *Chaetoceros denticulatus* LAUDER forma *lata* given in A. SCHMIDT, Atlas, Pl. 324, figures 6, 6a, 7. 48—65 broad.

Fig. 54 Part of a chain. Breadth, 65  $\mu$ .  $\times$  750.

#### 5 *Chaetoceras rostratum* LAUDER

1864, p. 79, Pl. 8, f. 10.

Resembles *C. denticulatum*, but usually smaller. No processes or teeth on setae. Prominent, tubular, conical, central process on valves. Setae with small spines, striated. Not common.

10—20  $\mu$  broad.

Fig. 55 Single cell. Breadth, 12  $\mu$ .  $\times$  750.

„ 55a Part of a cell. Breadth, 10  $\mu$ .  $\times$  1500.

„ 55b Part of a seta.  $\times$  1500.

#### 6 *Chaetoceras peruvianum* BRIGHTWELL

1856, p. 107, Pl. 7, f. 16-18.

Synonyms: *Chaetoceras peruvianum* var. *currens* PÉRAGALLO. Diat. Mar. de France, Pl. 125, f. 2, 3 (1904).

*Chaetoceras convexicornis* MANGIN, Bull. Mus. Hist. Nat. (1919), p. 3.

*Chaetoceras peruvianum* var. *currens* FORTI, R. Comit. Talasiogr. Ital., Mem. 97, p. 149, Pl. 11, f. 181 (1922).

Usually single cells. Valves unlike, upper rounded, lower flat. Setae

of upper valve spring from near center, after short basal part turn sharply and run backward in more or less wide, outwardly convex curves, at the end more or less divergent to convergent. Setae of lower valve spring from near margin, slightly convex toward the outside, more nearly parallel to perivalval axis than those of upper valve. At end more or less divergent or even convergent. All setae very strong, 3—6  $\mu$  thick; four-cornered with strong spines on the corners; striated, 20—22 lines in 10  $\mu$ . Not common.

Breadth, 12—20  $\mu$ .

Fig. 56 Single cell. Breadth, 12  $\mu$ .  $\times$  160.

„ 56a Single cell with basal part of setae. Breadth, 12  $\mu$ .  $\times$  750.

„ 56b Part of an anterior seta.  $\times$  1500.

„ 56c Part of a posterior seta.  $\times$  1500.

form *robusta* (CLEVE) HUSTEDT

1873a, GLEVE, p. 9, Pl. 2, f. 8.

1920, HUSTEDT, in A. SCHWIDT, Atlas, Pl. 325, f. 4.

Larger, heavier than type. Especially heavier setae, 6—8  $\mu$  thick. Breadth, 22—34  $\mu$ . Common.

Fig. 57 Single cell with part of setae. Breadth, 30  $\mu$ .  $\times$  160.

„ 57a Single cell. Breadth, 34  $\mu$ .  $\times$  750.

## Sub-genus II. — Hyalochaete

### Section 1. — Dicladia

#### 7 *Chaetoceras Lorenzianum* GRUNOW

1863, p. 157, Pl. 5, f. 13.

Chains straight, stiff. Apertures of varying size, 4 to 6 sided, seldom elliptical. Setae from corners of apical axis with definite but often short basal part, run somewhat diagonally outwards. Terminal setae shorter than others, often thicker, diverging rapidly from base at first, then more slowly until often nearly parallel with chain axis. Setae strongly punctated. Very common.

Breadth variable, 18—60  $\mu$ .

Fig. 58 Part of a chain. Breadth, 36  $\mu$ .  $\times$  325.

„ 58a-c Parts of three broad chains. Breadth, a, 53  $\mu$ ; b-c, 60  $\mu$ .  
 $\times$  325.

„ 58d Part of a center seta.  $\times$  1500.

„ 58e Part of a terminal seta.  $\times$  1500.

Section 2. — *Cylindrica*8 *Chaetoceras Lauderii* RALFS

1864, in LAUDER, p. 77, Pl. 8, f. 3, 4.

Synonym: *Chaetoceras Weissflogii* SCHÜTT.

1895, p. 44, f. 17.

Chains somewhat twisted. Apertures narrow, elliptical. Small spine in center of terminal valve. Intercalary bands, numerous, not visible in water mounts. Resting spore with strongly curved primary valve. Many spines on dome-shaped upper part, margin with circle of parallel needles, directed upward. Lower valve not observed in this material. Rare.

Breadth of cell, 19—30  $\mu$ .Fig. 59 Part of a chain. Breadth, 26  $\mu$ .  $\times$  325.,, 59a Cell showing intercalary bands. Breadth, 19  $\mu$ .  $\times$  750.,, 59b Part of a chain. Breadth, 20  $\mu$ .  $\times$  325.,, 59c Part of a terminal seta.  $\times$  1500.,, 59d Primary valve of a resting spore. Breadth, 22  $\mu$ .  $\times$  1500.Section 3. — *Compressa*9 *Chaetoceras compressum* LAUDER

1864, p. 78, Pl. 8, f. 6.

Chains often slightly twisted. Apertures more or less wide, sometimes only a slit, usually four- or six-sided, elliptical, slightly narrower in middle. Setae arise from inside margin, basal part always distinct. Species characterized by having some setae in chain greatly thickened and bent to run almost parallel to chain axis. Most of setae thin and not parallel. Fairly common.

Breadth, 12—24  $\mu$ .Fig. 60 Part of a chain showing thickened setae. Breadth, 24  $\mu$ .  
 $\times$  750.,, 60a Part of a thickened seta.  $\times$  1500.Section 4. — *Protuberantia*10 *Chaetoceras didymum* EHRENBERG

1845, p. 76; 1854, P. 35A, f. XVII, 5, and XVIII, 4.

Chains straight. Semicircular knob or protuberance in middle of valve. Setae arise from corners of cells, cross at base or slightly further out. Not common.

20—32  $\mu$  broad.Fig. 61 Part of a chain. Breadth, 20  $\mu$ .  $\times$  750.

var. *protuberans* (LAUDER) GRAN and YENDO

1864, LAUDER, Pl. 8, f. 11.

1914, GRAN and YENDO, p. 12, f. 5.

Similar to type. Terminal setae as a rule thicker than the others and more strongly divergent than in the type; convex toward outside, U-shaped. Setae usually crossed further out from chain than in type. Not common.

Breadth, 24—28  $\mu$ .Fig. 62 Part of a chain, with terminal cell. Breadth, 24  $\mu$ .  $\times$  750.,, 62a Part of a terminal seta.  $\times$  1500.var. *anglica* (GRUN.) GRAN1881, GRUNOW, in V. H. Syn., Pl. 82, f. 3; *Chaetoceras furcellatus* var. *anglica*.

1905, GRAN, p. 79-80, f. 95.

Crossing point of setae usually far outside chain. Apertures wide. Not common.

Breadth, 8—18  $\mu$ .Fig. 63 Part of a chain. Breadth, 9  $\mu$ .  $\times$  750.Section 5. — *Constricta*11 *Chaetoceras constrictum* GRAN

1897, p. 17, Pl. 1, f. 11-13, Pl. 3, f. 42.

Chains straight. Deep constriction between valves and girdle band. Apertures lanceolate, slightly narrowing in center. Setae with no basal part. Terminal setae diverge at acute angle. Not common.

Breadth, 24—26  $\mu$ .Fig. 64. Part of a chain. Breadth, 24  $\mu$ .  $\times$  750.12 *Chaetoceras Van Heurckii* GRAN

1897, p. 18.

Positive identification of the present species difficult due to absence of resting spores. General appearance of chain and direction of setae in accord with published figures (see SCHMIDT, Atlas, Pl. 344, f. 1, 2, 8). Chain straight, apertures lanceolate to narrow-elliptic, slightly constricted in center. Girdle about one-third of cell, with constricted sutures. Setae usually all more or less curved toward one end of chain. Terminal setae slightly thickened and spinous, but less so than figured in specimens from other localities. Common.

Breadth, 24—28  $\mu$ .

Fig. 65 Part of a chain. Breadth, 48  $\mu$ .  $\times$  325.

„ 65a, b Portions of two chains drawn from water mounts.

a, breadth, 24  $\mu$ .  $\times$  750.

b, breadth, 25  $\mu$ .  $\times$  325.

„ 65c Part of a chain. Breadth, 32  $\mu$ .  $\times$  750.

„ 65d Part of a terminal seta.  $\times$  1500.

#### Section 6. — *Stenocincta*

##### 13 *Chaetoceras affine* LAUDER

1864, p. 68, Pl. 8, f. 5.

(1) Synonym: *Chaetoceras javanicum* CL.

1873a, p. 10, Pl. 2, f. 13.

Chain straight. Apertures narrow, lancet-shaped, usually slightly constricted in center. Terminal setae strongly divergent, slightly thickened, with small spines arranged spirally. Small protuberance or spine present in center of terminal frustule. Common.

Breadth, 22  $\mu$ .

Fig. 66 Part of a chain. Breadth, 22  $\mu$ .  $\times$  325.

„ 66a, b Parts of a terminal seta.  $\times$  1500.

(2) Synonym: *Chaetoceras Schüttii* CL.

1894, p. 14, Pl. 1, f. 1. (See also MEUNIER. 1910, Pl. 26, f. 32-35).

Chain straight. Apertures lancet-shaped to elliptical, occasionally slightly constricted in center. Terminal setae thickened slightly, strongly divergent, at almost right angles to chain axis, then further out bent to run almost parallel to axis or even away from it. Small spine in center of terminal valve. Not common.

Breadth, 6—9  $\mu$ .

Fig. 66c, d Parts of two chains. Breadth, 66c, 18  $\mu$ ; 66d, 6  $\mu$ .  
 $\times$  750.

##### 14 *Chaetoceras paradoxum* CLEVE

1873a, p. 10, Pl. 3, f. 16.

Chains usually twisted. Cell wall thickened. Deeply constricted girdle-bands. Apertures large; oval. Tiny spine in center of terminal valve. Setae with flat elevations or spines. Common.

Cell 13—28  $\mu$  broad.



- Fig. 67 Part of a chain with terminal cell. Breadth, 28  $\mu$ .  $\times$  750.  
 „ 67a Part of a chain in narrow girdle view. Breadth, 13  $\mu$ .  
 $\times$  750.  
 „ 67b, e. Parts of two chains. 67b, breadth, 24  $\mu$ .  $\times$  325. 67e,  
 breadth, 14  $\mu$ .  $\times$  750.  
 „ 67c, d Parts of a seta, 67c nearer end than 67d.  $\times$  1500.

#### Section 7. — Laciniosa

##### 15 *Chaetoceras distans* CLEVE.

1894, p. 14, Pl. 2, f. 2.

Very similar to *C. lacinosum* SCHÜTT. Differentiated by suture lines of girdle bands, convex towards apertures in present species, parallel in *C. lacinosum*. Not common.

Breadth of cell, 16—24  $\mu$ .

- Fig. 68 Part of a chain with terminal cell. Breadth, 24  $\mu$ .  $\times$  750.  
 „ 68a Part of a chain. Breadth, 16  $\mu$ .  $\times$  750.  
 „ 68b Part of a terminal seta.  $\times$  1500.

##### 16 *Chaetoceras lacinosum* SCHÜTT

1895, p. 38, f. 5.

Chains straight, not twisted. Apertures large, broad, oblong, with rounded corners. Slightly constricted in middle. Setae thin, basal part parallel with chain, outer part bent toward one end of chain. Terminal setae less thickened in specimens observed than characteristic. More or less parallel with chain axis. Not common.

Breadth, 12  $\mu$ .

Closely resembles *C. pelagium* CLEVE (GRAN, 1905, p. 83—4, f. 101). Included in present species by GRAN, 1915. HUSTEDT, 1930, retains it as separate species.

- Fig. 69 Part of a chain. Breadth, 12  $\mu$ .  $\times$  750.

##### 17 *Chaetoceras breve* SCHÜTT

1895, p. 38, f. 4.

Closely resembles *C. lacinosum*. Differentiated by setae almost straight, not so far from apical plane. Aperture wide, 4 or 6 sided, elliptical, more or less narrowed in center. Crossing point of setae somewhat outside the chain. Not common.

Breadth, 24  $\mu$ .

- Fig. 70 Part of a chain. Breadth, 24  $\mu$ .  $\times$  750.

Section 8. — *Diversa*18 *Chaetoceras diversum* CLEVE

1873a, p. 9, Pl. 2, f. 12.

Chains straight, usually short. Apertures small, sometimes absent. Setae various, some hair-like, others longer, thickened, with fine spines. Outer half of thickened setae enlarged, then small again at tip. Terminal setae always thin, hair-like. Common.

Breadth, 7—12  $\mu$ .Fig. 71 Part of a chain. Breadth, 12  $\mu$ .  $\times$  325.,, 71a Part of a chain. Breadth, 10  $\mu$ .  $\times$  1500.,, 71b Part of a thickened seta.  $\times$  1500.19 *Chaetoceras laeve* LEUDIGER-FORTMOREL

1892, p. 38, Pl. 6, f. 2.

Closely resembles *C. diversum* except in direction of setae; all setae, thick and thin ones, having characteristic curvature. At first nearly parallel and then abruptly turn off at right angle and converge slightly toward chain axis. Thick setae approximately same size throughout length. Structure of setae same in both species. Not common.

Breadth, 8—12  $\mu$ .Fig. 72 A chain of three cells. Breadth, 12  $\mu$ .  $\times$  325.,, 72a Part of a chain. Breadth, 10  $\mu$ .  $\times$  1500.,, 72b Part of a heavier, center seta.  $\times$  1500.Section 9. — *Curviseta*20 *Chaetoceras pseudocurvisetum* MANGIN

1910, p. 350, figs. 3 II, 4 II.

Chains spirally twisted. Cells characterized by four protuberances on each valve, in contact with corresponding protuberances on adjoining valve. Two pairs of apertures, one pair large, elliptic-lanceolate in broad girdle view, other pair smaller, almost spherical. Setae with spiral rows of tiny bristles, all turned toward convex side of chain. Intercalary bands present in some specimens. Common.

Breadth, 18—22  $\mu$ .Fig. 73 Part of a chain in broad girdle view. Breadth, 18  $\mu$ .  $\times$  750.,, 73a, b Parts of two chains in narrow girdle view; a more turned than b. Breadth, a, 16  $\mu$ ; b, 20  $\mu$ .  $\times$  750.,, 73c View showing protuberances. Breadth, 20  $\mu$ .  $\times$  1500.,, 73d Part of a seta.  $\times$  1500.

(18) Genus *EUCAMPIA* EHRENBURG

Valves elliptical in surface view with two blunt processes but no bristles or setae. Numerous intercalary bands, difficult to see. Chains spirally curved. Large apertures between the cells.

1 *Eucampia zoodiacus* EHR.

1838*b*, p. 71, Pl. 4, f. 8.

Cells flattened, elliptical-linear in valve view, united in chains by two blunt processes. Without bristles. Intercalary bands numerous, difficult to see in water mounts. Chains spirally curved, with relatively large elliptical to nearly spherical apertures. Apertures decidedly variable in size and shape. Valves distinctly sculptured, with puncta in more or less regular radial rows running from center outward toward processes. 16—20 puncta in 10  $\mu$ . Sculpturing on intercalary bands visible only under high magnification; rows (21 —25 in 10  $\mu$ ) of minute puncta. Common.

Breadth of chain, 36—46  $\mu$ .

Fig. 74 Part of a chain. Breadth, 46  $\mu$ .  $\times$  750.

, 74*a* Sculpturing.  $\times$  1500.

2 *Eucampia cornuta* (CLEVE) GRUNOW

1873*a*, Cleve, p. 7, Pl. 1, f. 6, *Mölleria cornuta*.

1881, VAN HEURCK, Synopsis, Pl. 95 bis, f. 5.

Similar to *Eucampia zoodiacus* in character of chain and general appearance. Differentiated by much more prominent intercalary bands, and longer, thinner processes so that the apertures are wider. Sculpturing on valves similar, but not identical, in more definite rows from center to ends of processes; about 13 to 16 puncta in 10  $\mu$ . Surface of intercalary bands similarly punctated; very fine puncta in rows. Rows 22—26 in 10  $\mu$  running in direction of pervalval axis. Less common than *E. zoodiacus*.

Breadth of cell (length of apical axis), 54—61  $\mu$ .

Fig. 75 Girdle view of a cell. Breadth, 61  $\mu$ .  $\times$  750.

„ 75*a* Sculpturing.  $\times$  1500.

(19) Genus *CLIMACODIUM* GRUNOW

Chains straight with squarish oblong gaps left by the hammer-like ends of the cells, or oval gaps. Cell-wall very weakly siliceous.

1 *Climacodium Frauenfeldianum* GRUNOW

1868, p. 102, Pl. 1a, f. 24.

Chains straight with very large more or less square to oblong apertures between cells. Cells flat, with more or less hammer-shaped ends. Intercalary bands absent. Cell-wall very weakly siliceous. Not common.

Breadth of chain (length of apical axis) 169—171  $\mu$ ; perival axis 14—21  $\mu$  long.

Fig. 76 Part of a chain. Breadth, 171  $\mu$ .  $\times$  325.

(20) Genus **STREPTOTHECA** SHRUBSOLE

Cells extremely flat, sometimes three cornered, with square outline, united by valve faces, leaving very little, if any, aperture. Cell-wall very weakly siliceous. Chains strongly twisted. Valves narrowly elliptical with a rudimentary central knob.

1 *Streptotheca indica* KARSTEN

1907, p. 395, Pl. 46, f. 8, a. b.

In girdle view cell square or rectangular, valve surface flat with slight depression in center. No chains observed in this material. In valve view flat but less thin than usually figured for *S. thamensis*. Length along apical axis 10—12 times as great as along transapical axis. Cell usually greatly twisted, often to be or appear to be three parted. Cell-wall very weakly siliceous. Not common.

Length along apical axis, 196  $\mu$ ; transapical axis, 18  $\mu$ ; perival axis, 95  $\mu$ .

Fig. 77 Girdle view of a cell. Length of apical axis, 196  $\mu$ .  $\times$  160.

„ 77a Three cornered cell, girdle view.  $\times$  160.

„ 77b Valve view of cell shown in 77.  $\times$  160.

„ 77c Valve view of cell shown in 77a.  $\times$  160.

(21) Genus **BELLEROCHEA** VAN HEURCK

Cells in flat chains touching by their valve centers and projecting corners. Cell-wall very weakly siliceous. Valve three cornered as a rule, with bipolar and four-cornered varieties. Valve margin with a delicate circle of short bristles. Intercalary bands present but very difficult to see.

1 *Bellerochea malleus* (BRIGHTWELL) VAN HEURCK1858, BRIGHTWELL, p. 154, Pl. 8, f. 6, 7. *Triceratium malleus*.

1885, VAN HEURCK, Syn. p. 203.

form *biangulata* HUSTEDT (= var. *biangulata* PÉRAG.)

1908, PÉRAGALLO, p. 394.

1930, HUSTEDT, p. 782, f. 456 d.

Cells more or less rectangular, in flat, somewhat curved, chains touching by their valve centers and projecting corners. Apertures small, largest just inside valve margin. Cells pseudozygomorphic, valve surface bipolar, elliptical-lanceolate, the chain therefore not prism-shaped as in the type, but band-like. Circle of short-bristles on valve margin not observed. Cell-wall very weakly siliceous. Not common.

Breadth of chain (length of apical axis), 74  $\mu$ .

Fig. 78 Part of a chain in broad girdle view. Breadth, 74  $\mu$ .  $\times$  750.

„ 78a Part of a chain in narrow girdle view.  $\times$  750.

„ 78b Valve view.  $\times$  750.

## (22) Genus DITYLUM L. BAILEY

Valve three- to four-cornered, seldom bipolar, with a strong central siliceous straight hollow spine and a marginal ridge strengthened by ribs. Cells elongated, prism-shaped to cylindrical. Intercalary bands more or less numerous. Valve surface more or less waved, with usually poorly developed humps on the corners, in the central part a usually three-cornered elevated region the margin of which often has a circle of short perivalval directed spines. Outer valve margin more or less strongly waved, giving the appearance of lines running from valve to valve. Cell-wall weakly siliceous, the valve membrane delicately areolated-punctated. Solitary or united into chains by the spines.

### 1 *Ditylum sol* GRUNOW

1881, in VAN HEURCK, Syn. Pl. 115, f. 1, 2.

Valve three-cornered, with a strong central siliceous straight hollow spine. Definite circle of small spines on valve absent, although the base for the spines is present. Valve margin waved, giving the appearance of numerous longitudinal parallel lines in girdle view. Fine punctation on valves, in rows, 19—20 puncta in 10  $\mu$ . Intercalary bands not observed. Fairly common.

Diameter, 36—158  $\mu$ .

Fig. 79 Valve view. Length along side, 158  $\mu$ .  $\times$  750.

„ 79a Cell in girdle view. Breadth, 85  $\mu$ .  $\times$  325.

„ 79b Cell in girdle view. Breadth, 36  $\mu$ .  $\times$  325.

„ 79c Part of valve mantle indicating structure.  $\times$  1500.

(23) Genus *BIDDULPHIA* GRAY

Cells single or in chains with more or less strongly siliceous cell-wall, not twisted. Valves elliptical or three- or four-sided (rarely five-sided). More or less distinct processes may be present at the corners or at the ends of the apical axis. Very fine slime-pores usually present on the end surfaces of the processes or on the corners of the valves. Plankton forms usually held together in chains by long spines. Girdle zone sharply differentiated from the valve zone, cylindrical or prism-shaped, with numerous cross striae, but usually without intercalary bands.

1 *Biddulphia mobiliensis* (BAIL.) GRUNOW

1851, BAILEY, p. 40, Pl. 2, f. 34, 35.

1885, GRUNOW, in V. H., Syn., Pl. 101, f. 4-6; Pl. 103, f. A.

Cells single or united in short chains by the long spines. Relatively thin-walled, without a sharp constriction between valve and girdle zone. Valves elliptical. Valve processes slender, directed diagonally outwards. Two large, straight spines placed far apart, but about equally far from the processes, directed obliquely outwards. Occasionally a few scattered small spines on valve between processes. Valve surface between the processes almost flat to slightly concave. Cell-wall with fine areolation, 14-16 areoles in 10  $\mu$  on valve; 17-19 in 10  $\mu$  on girdle bands. Not common.

Length of apical axis, 36-50  $\mu$ .

Fig. 80 Two cells in a chain. Breadth, 36  $\mu$ .  $\times$  750.

„ 80a Single cell in girdle view. Breadth, 50  $\mu$ .  $\times$  750.

„ 80b Process and part of valve mantle showing sculpturing.  $\times$  1500.

„ 80c Sculpturing of girdle band.  $\times$  1500.

2 *Biddulphia sinensis* GREVILLE

1866, p. 81, Pl. 9, f. 16.

Cells flat cylindrical, elliptical-lanceolate in valve view, with elongated perivalval axis. No constriction between valve and girdle band. Thin but well-developed process from each pole of apical axis, directed nearly parallel to perivalval axis or faintly incurved. Strong spines project from small elevations near the processes, directed nearly parallel to processes, slightly curved inward at ends, thinner near ends. Central part of valve flat or a little concave. Cell-wall weakly siliceous. Delicately areolated,

on valve about 14—16 areoles in  $10\ \mu$ ; on girdle band somewhat finer, 17—18 in  $10\ \mu$ . Common.

Length of apical axis, 54—245  $\mu$ .

- Fig. 81 Cell in girdle view. Breadth, 85  $\mu$ .  $\times$  325.  
 „ 81a Another cell in girdle view. Breadth, 136  $\mu$ .  $\times$  325.  
 „ 81b Sculpturing of valve mantle.  $\times$  1500.  
 „ 81c Sculpturing of girdle band.  $\times$  1500.  
 „ 81d Process and part of valve mantle indicating sculpturing.  $\times$  1500.

### 3 *Biddulphia heteroceros* GRUNOW

In SCHMIDT, Atlas, Pl. 141, f. 6.

VAN HEURCK, Synopsis, Pl. 102, f. 5.

Valves rounded-rhombic in valve view. Without a sharp constriction between valve and girdle zone. Process from each pole of apical axis well-developed, directed slightly away from pervalval axis. Strong spines project from valve surfaces a short distance from the processes, nearly parallel to processes at first, then slightly incurved. Valve between spines only slightly higher than between spines and processes, nearly flat, with tiny humps or prominences from which prominent more or less delicate spines project. Numerous fine spines distributed over whole valve surfaces. A hyaline collar supported by heavy ribs present on lower margin of valve mantle, next to girdle band. Areolation of practically equal size on valve and girdle, 15—16 areoles in  $10\ \mu$ . Not common.

Length of apical axis, 30—54  $\mu$ .

Processes figured in SCHMIDT as somewhat shorter and stouter than in the present specimens.

- Fig. 82 Cell in broad girdle view. Breadth, 50  $\mu$ .  $\times$  750.  
 „ 82a Part of cell showing sculpturing on valve mantle and girdle band.  $\times$  1500.  
 „ 82b Part of a cell tipped to show shape of valve in valve view. Breadth, 48  $\mu$ .  $\times$  750.  
 „ 82c Part of another cell showing spines on mantle and projecting from surface of valve.  $\times$  750.

### 4 *Biddulphia reticulum* (EHR.) BOYER

1844, EHRENBURG, p. 88, *Triceratium reticulum*.

1900, BOYER, p. 724.

Synonym: *Triceratium punctatum* BRIGHTW.

1856, p. 275, Pl. 9, f. 18; in SCHMIDT, Atlas, Pl. 76, f. 19—20.

Valves triangular with either straight or slightly convex sides. Pervalval axis more or less elongated. Angles of valves rounded, sometimes slightly produced. Valve surface slightly elevated or almost flat in the center, then depressed into a small furrow at each side so that the rounded corners appear as processes in girdle view. Top of rounded corners and valve center at nearly the same level. Cell-wall areolated; areoles more or less irregular in size and far apart; in center part of valve without any particular order, near margin in more or less radial, perivalval rows about 5—7 in 10  $\mu$ . Valve corners finer areolated, 13—15 areoles in 10  $\mu$ . Girdle band with 10—12 areoles in 10  $\mu$ , in more or less regular rows. Not common.

Length of apical axis, 22—42  $\mu$ .

Fig. 83 Single cell in girdle view. Breadth (apical axis) 38  $\mu$ ; length (transapical axis) 32  $\mu$ .  $\times$  1500.

„ 83a Cell in process of division. Breadth, 22  $\mu$ .  $\times$  1500.

„ 83b Flatter cell. Breadth, 42  $\mu$ ; length, 24  $\mu$ .  $\times$  750.

„ 83c Valve view. Length along side, 30  $\mu$ .  $\times$  1500.

##### 5 *Biddulphia dubia* (BRIGHTW.) CLEVE

1859, BRIGHTWELL, p. 180, Pl. 9, f. 12, *Triceratium dubium*.

1883, CLEVE, p. 508.

Synonym: *Triceratium* (or *Biddulphia*) *bicorne* CLEVE, 1878, p. 17, Pl. 5, f. 30.

In SCHMIDT, Atlas, *T. bicorne*, Pl. 78, f. 24—25.

Valves rhombic-lanceolate. Side view with two angles having a stout horn-like prolongation and with two having a shorter, blunter process. Sculpture of valves large and somewhat irregular hexagonal chambers, 5—8 in 10  $\mu$ . Striated margins prominent in valve view. Minute punctae on valve surface. Girdle band areolated, about 12 areoles in 10  $\mu$  near valve margin, 13—14 in center, arranged in rows, 8 in 10  $\mu$ . Rare.

Length of apical axis, 28—30  $\mu$ .

Distance between produced angles, 48—50  $\mu$ .

Fig. 84 Girdle view. Length of apical axis, 30  $\mu$ .  $\times$  1500.

„ 84a Valve view.  $\times$  1500.

„ 84b Diagram of whole cell.  $\times$  750.

##### 6 *Biddulphia* species

A. SCHMIDT, Atlas, Pl. 93, f. 6, 7,

Valve triangular, with slightly convex sides. Surfaces divided into large hexagonal cells, in rows not parallel to the sides, 3—3½ in 10  $\mu$



in center, 5 in  $10\ \mu$  near margin, 7 in  $10\ \mu$  on margin. Inner surface of valve finely punctuated; the puncta, about 18—19 in  $10\ \mu$ , radiating in undulating lines from the center. Girdle view narrow rectangular. Surface slightly convex to almost flat. Angles produced into very short processes. Not common.

Identification uncertain. The specimen shown in SCHMIDT, Atlas, Pl. 93, f. 6, 7, seems to correspond to the present species. A note in connection with the figures states that GRUNOW had remarked that this form reminded him of *Triceratium megastomum* (E.?) BRIGHTW. and *Tr. constans* GREV., but that he could not identify it definitely because of the absence of necessary views. It seems more probable that it is a form or variety of *Biddulphia favus* (EHR.) VAN HEURCK (1885, Synopsis, p. 208).

Fig. 85 Valve view. Length along side,  $143\ \mu$ .  $\times 750$ .

#### (24) Genus CERATAULINA H. PÉRAGALLO

Cells cylindrical, valves slightly rounded with two stumpy processes near the margin, which hold on to the corresponding processes of the neighbouring cells by a little curved hair that fits into a sheath in the neighbouring cell. Intercalary bands numerous. Usually in more or less long chains. Cell-wall weakly siliceous.

##### 1 *Cerataulina Bergonii* H. PÉRAG.

1892, p. 7, Pl. 1, f. 15.

Cells cylindrical, circular in valve view, more or less elongated along pervalval axis; united into straight or usually slightly curved chains. Intercalary bands numerous, collar-shaped, difficult to see. Valve with slightly convex surface and short valve mantle. On margin of valves two short cylindrical processes opposite each other with a hair-like delicate spine. Cells united into chains with end surfaces of processes together and spine in a sheath in neighbouring cell so that only very small apertures are present. Cell-wall weakly siliceous. Valve with radial rows of puncta about 22 in  $10\ \mu$ . Common but not abundant.

Diameter,  $30\text{--}36\ \mu$ .

Fig. 86 Part of a chain. Diameter,  $30\ \mu$ .  $\times 325$ .

„ 86a Part of two cells, narrow girdle view, showing method of joining.  $\times 1500$ .

„ 86b Valve view. Rows of puncta indicated.  $\times 1500$ .

2 *Cerataulina compacta* OSTENFELD

1901, in OSTENFELD and SCHMIDT, p. 153, f. a—d.

Cells elongate-cylindrical. Valves flattened instead of rounded. Processes on valves short, oblique, with flatter end surfaces than in *C. Bergonii*, situated in the prolongation of hoop-surface, not within it; spines slightly heavier. Cells united into stiff usually straight chains by end surfaces of processes. Very small apertures, often absent. Intercalary bands numerous, collar-like. Cell-wall weakly siliceous. Punctation on valves fine, about 18 puncta in  $10\ \mu$ , in rows. Common but not abundant.

Diameter,  $34\text{--}61\ \mu$ ; length along perivalval axis,  $100\text{--}160\ \mu$ .

Fig. 87 Part of a chain. Diameter,  $34\ \mu$ .  $\times 750$ .

„ 87a Part of a cell indicating sculpturing of valve. Diameter,  $34\ \mu$ .  $\times 1500$ .

„ 87b Part of two cells showing method of uniting.  $\times 750$ .

(25) Genus *HEMIAULUS* EHRENBERG.

Cells single or united in chains. Valves elliptical in section, with two narrow pointed more or less long polar processes which are parallel with the cell axis. One or more hyaline claws on the end of the processes. Intercalary bands usually indistinct or absent. Membrane strongly or weakly siliceous, finer or coarser areolated or punctated. Cells more or less bent.

1 *Hemiaulus sinensis* GREVILLE1865, Pl. 5, f. 9 (*H. chinensis*):Synonym: *Hemiaulus Heibergii* CLEVE.

1873a, p. 6, Pl. 1, f. 4.

Cells broadly elliptical in valve view, more or less elongated along perivalval axis, greatly variable apical axis. In more or less long usually curved chains. Valve surface slightly convex to almost flat. Processes on valves thin but strong with a strong claw on the ends. Cell-wall strongly siliceous. Cell-membrane distinctly sculptured. Lines of areoles running from a decidedly excentric point on the valve surface. Near center of valve 7—9 areoles in  $10\ \mu$ , near margin 11—12 in  $10\ \mu$ . Very fine punctation on girdle band, 21—23 rows in  $10\ \mu$ . Common.

Length along apical axis,  $18\text{--}75\ \mu$ .

Fig. 88 Cell in girdle view showing point from which areoles run.

Length of apical axis,  $36\ \mu$ .  $\times 1500$ .

- Fig. 88a Other side of valve shown in 88.  
 „ 88b Two cells recently divided.  $\times 750$ .  
 „ 88c Part of a chain, narrow girdle view.  $\times 750$ .

## 2 *Hemiaulus indicus* KARSTEN

1907, p. 394. Pl. 46, f. 4, a.

Cell from circular to elliptical in valve view. Valves strongly rounded, with two comparatively short processes on each valve which unite the cells into more or less long, straight or slightly curved chains. Presence or absence of sculpturing uncertain, only water mounts studied. Not common.

Diameter, 34—40  $\mu$ .

Fig. 89 Two cells in a chain. Slightly twisted. Diameter, 36  $\mu$ .  
 $\times 750$ .

„ 89a Same chain in straight broad girdle view. Drawn from water mounts.

## 3 *Hemiaulus membranacus* CLEVE

1873a, p. 6, Pl. 1, f. 5.

(See figures in SCHMIDT, Atlas, Pl. 142, f. 13, 14, 15).

Cells in girdle view of varying shapes from almost square to 5—6 times wider (apical axis) than long (perivalval axis). Valve slightly convex, concave, or nearly flat between processes. Processes short, often with a more or less sharp point. United in chains by processes. Apertures narrow, linear to elliptical. Cell-wall very weakly siliceous. Very fine punctation on valves, 17—23 puncta in 10  $\mu$ ; apparently not in regular lines but very difficult to observe. Not common.

Breadth, 67—97  $\mu$ .

Fig. 90 Cell in broad girdle view. Breadth, 67  $\mu$ .  $\times 750$ .

„ 90a Two cells in a chain. Breadth, 73  $\mu$ .  $\times 750$ .

„ 90b Cell in broad girdle view. Breadth, 91  $\mu$ .  $\times 750$ .

„ 90c Process showing sculpturing.  $\times 1500$ .

## (26) Genus HEMIDISCUS WALLICH

Cell shaped like a sector of a sphere, in girdle view wedge-shaped narrowing from the dorsal toward the ventral side. Valve semi-circular to asymmetrically elliptical. Valves flat with short valve mantles. Intercalary bands and septa absent, perivalval axis not especially elongated. Cell-wall weakly or strongly siliceous, with regular areolation, rows

radial, frequently in bundles. Marginal spinulae often present, also sometimes a pseudonodule near the middle of the ventral valve margin. With or without a central hyaline area.

1 *Hemidiscus Hardmanianus* (GREV.) MANN

1865, GREVILLE, p. 1, Pl. 5, f. 1-4, *Palmeria Hardmaniana*.  
1907, MANN, p. 316.

Valves semi-circular, with a straight ventral margin and obtuse ends. Central area hyaline. Areolation fine, in lines radiating from the central area. Areoles more or less hexagonal, irregular along the straight margin; just above the margin 12—13 in  $10\ \mu$ ; near the center 13—14 in  $10\ \mu$ . Spinulae around the margin, 4— $10\ \mu$  apart, with hyaline ribs arising from them and running toward the center. Girdle very unequal, narrow on straight side of valve, very broad on curved side. The cell, as a result of the unequal girdle, resembles a section of an orange. Previous to division the cell is nearly hemispherical. Dried specimens are of a dark fawn color resembling that of *Coscinodiscus nobilis*.

J. BRUN (1891, p. 26, Pl. 17, f. 4) describes and figures a species which he calls *Euodia (Hemidiscus) capillaris*, but which is apparently a synonym of the present species.

Abundant in some catches.

Length along straight margin, 504—534  $\mu$ ; width, 250—270  $\mu$

Fig. 91 Center of valve.  $\times 1500$ .

„ 91a Valve with marginal spinulae and hyaline ribs indicated.  
Length, 534  $\mu$ ; width, 257  $\mu$ .  $\times 160$ .

„ 91b Section of valve from center of straight margin to center of valve.  $\times 750$ .

„ 91c Section near margin showing structure.  $\times 1500$ .

„ 91d Valves of a cell just before division.  $\times 80$ .

„ 91e Other side of cell shown in Fig. 91d.  $\times 80$ .

## PENNATAE

### (1) Genus LICMOPHORA AGARDH

Cells in girdle view three-cornered, attached by mucous stalk to algae, etc. Valves at lower end narrow and pointed, at the upper end broader, usually rounded. With a middle pseudoraphe. Girdle zone with intercalary bands, one of which in each valve pierces the cavity like a septum above, open below.

1 *Licmophora Lyngbyei* (KÜTZ.) GRUN.

1844, KÜTZING, p. 121, Pl. 9, f. X. 3, *Podosphenia Lyngbyei* KÜTZ.  
1867, GRUNOW, p. 35, *Licmophora Lyngbyei* GRUN,

Cell in girdle view three-cornered, both upper corners rounded, lower straight where attached to mucous stalk (not observed in this material). Valves club-shaped, with distinct pseudoraphe and fine striae perpendicular to it. Striae 11—12 at the base, 13—14 above. Not common.

Length, 42—50  $\mu$ .

Fig. 92 Girdle view of cell. Length, 42  $\mu$ .  $\times$  1500.

## (2) Genus RAPHONEIS EHRENBERG

Cell in valve view lanceolate to elliptical, often rostrate on ends. Valves with transverse and sagittal line free of puncta. Pseudoraphe more or less distinct, often very small, often irregular, finely punctated. Girdle view rectangular; with regular sides.

1 *Raphoneis ampiceros* EHR.

1844, p. 87.

Cell lanceolate, inflated at the center. Pseudoraphe small, linear. Large puncta form transverse lines or striae, about 12 in 10  $\mu$ . Littoral form. Rare.

Length, 24  $\mu$ ; width, 12  $\mu$ .

Fig. 93 Valve view. Length, 24  $\mu$ .  $\times$  1500.

2 *Raphoneis surirella* (EHR.?) GRUN.

In VAN HEURCK, Synopsis, p. 147, Pl. 36, f. 26, 27a.

Cell linear-elliptical, very slightly inflated at center. Pseudoraphe conspicuous, narrow, dilated at the extremities. Large puncta in transverse striae, 13 in 10  $\mu$ . Littoral form. Rare.

Length, 20—22  $\mu$ ; width, 7—8  $\mu$ .

Fig. 94 Valve view. Length, 22  $\mu$ .  $\times$  1500.

## (3) Genus THALASSIOTHRIX CLEVE and GRUNOW

Cells rod-shaped, straight or slightly bent, single or united into star-like or zigzag colonies. Valves linear. Without pseudoraphe. With similar or slightly different poles which hold the cells together.

1 *Thalassiothrix elongata* GRUNOW

1880—1885, in VAN HEURCK, Synopsis, Pl. 37, f. 9.

Cells single thread-like. Valves very long, slightly curved; one end slightly pointed, the other rounded. Marginal striae 9—14 in 10  $\mu$ . Closely related to or possibly a synonym of the usually more northerly *Th. longissima* CLEVE and GRUNOW. Common in some samples.

Length, 1054—1260  $\mu$ ; width, 3—4  $\mu$ .

Fig. 95 Cell showing characteristic curvature. Length, 1098  $\mu$ .  
 $\times 80$ .

„ 95a Same cell. Valve view.  $\times 750$ .

„ 95b Valve view.  $\times 1500$ .

## 2 *Thalassiothrix Nitzschioides* GRUN.

1881, in VAN HEURCK, Synopsis, Pl. 43, f. 7.

Cells rod-shaped, straight, or slightly curved. United into star-shaped or zigzag chains. In girdle view elongated rectangular, in valve view linear or very narrow lancet-shaped. Both poles of valves alike. No pseudoraphe. Marginal striae 12—14 in 10  $\mu$ . Abundant in some catches.

Length of valve very variable, 18—20  $\mu$ ; width, 6—7  $\mu$ .

Fig. 96 Girdle view of chain. Length of cell, 68  $\mu$ .  $\times 325$ .

„ 96a Girdle view of chain of two cells. Length, 52  $\mu$ .  $\times 750$ .

„ 96b Part of a chain shown in 96a.  $\times 1500$ .

„ 96c Chain of nine cells. Cell on left end in valve view. Length of cell, 40  $\mu$ .  $\times 325$ .

## 3 *Thalassiothrix Frauenfeldii* (GRUN.) CLEVE and GRUNOW

1863, GRUNOW, p. 140, Pl. 14, f. 18, *Asterionella? Frauenfeldii*.

1880, CLEVE and GRUNOW, p. 109.

Cells rod-shaped, straight, or slightly curved. Colonies always star-shaped. Poles of valves morphologically distinct, although only slightly different. No pseudoraphe. Marginal striae 10—12 in 10  $\mu$ . Figured in VAN HEURCK, Synopsis, Pl. 37, f. 13, as *Th. Frauenfeldii* var.? *Javanica* GRUN. Abundant in some catches.

Length, 164—257  $\mu$ ; width, 8—12  $\mu$ .

Fig. 97 Girdle view of a single cell. Length, 257  $\mu$ .  $\times 325$ .

„ 97a Extremities of same cell.  $\times 1500$ .

„ 97b Chain of three cells. Length, 164  $\mu$ .  $\times 325$ .

## (4) Genus ASTERIONELLA HASSAL

Cells rod-like with distinctly dissimilar ends. United into star-like or spiral colonies in which the cells are united only by the thicker ends. Valves with a median pseudoraphe.

1 *Asterionella japonica* CLEVE

1882, CLEVE in CLEVE and MÖLLER, no. 307. 1877—82.

Colonies star-shaped, in spirals of somewhat great curvature. Inner part of cell in girdle view three-cornered, outer part hair-like; inner part in valve view oblong. Not common.

Breadth of cell, 74—129  $\mu$ ; length of inner thicker part, 14—16  $\mu$ .

Fig. 98 Part of a colony. Cells in girdle view. Length of cell, 74  $\mu$ .  
 $\times$  750.

„ 98a Valve view of a cell. Length, 110  $\mu$ .  $\times$  750.

(5) Genus **CAMPYLONEIS** GRUNOW

Valves dissimilar, in outline elliptical or orbicular. Upper valve without central nodule and median line, with pseudoraphe, with radiate rows of coarse puncta or alveoles. Lower valve with central nodule and median, straight raphe, without polar nodules, with radiate, finely punctated striae. Between both valves and connected to the lower valve by some vertical processes, is an interior siliceous skeleton of more or less complicated structure.

1 *Campyloneis Grevillei* (SM.) GRUN.

1862, GRUNOW, p. 429.

1853—58, SMITH, Syn. I, p. 22, Pl. 3, f. 35, *Cocconeis Grevillei*.

1867, GRUNOW, p. 11.

1894—95, CLEVE, Syn. I, p. 167, *Campyloneis Grevillei* var. *typica*.

Valve broadly elliptical, with rounded ends. Upper valve with a depressed, lanceolate area. Striae 6 in 10  $\mu$ ; outside of the area composed of distinct puncta, inside of short ribs, formed of fused puncta. Lower valve with straight median line, not reaching the margin; with radiate striae, 12—14 in 10  $\mu$ , made up of coarse puncta, 12—15 in 10  $\mu$ . Interior skeleton of transverse ribs connected by an axial rib. Rare.

Length, 44  $\mu$ ; breadth, 31  $\mu$ .

Fig. 99 View of lower valve and interior skeleton. Length, 44  $\mu$ ;  
 breadth, 31  $\mu$ .  $\times$  1500.

(6) Genus **NAVICULA** BORY

Cells usually free, capable of movement. Often united into ribbon-like chains in plankton forms. Both valves with raphe and central nodule. Halves of the raphe not surrounded by an elevated parallel ridge; both ends of each half terminating in a rounded or elongated bead; central and

1 *Asterionella japonica* CLEVE

1882, CLEVE in CLEVE and MÖLLER, no. 307. 1877—82.

Colonies star-shaped, in spirals of somewhat great curvature. Inner part of cell in girdle view three-cornered, outer part hair-like; inner part in valve view oblong. Not common.

Breadth of cell, 74—129  $\mu$ ; length of inner thicker part, 14—16  $\mu$ .

Fig. 98 Part of a colony. Cells in girdle view. Length of cell, 74  $\mu$ .  
 $\times$  750.

„ 98a Valve view of a cell. Length, 110  $\mu$ .  $\times$  750.

(5) Genus *CAMPYLONEIS* GRUNOW

Valves dissimilar, in outline elliptical or orbicular. Upper valve without central nodule and median line, with pseudoraphe, with radiate rows of coarse puncta or alveoles. Lower valve with central nodule and median, straight raphe, without polar nodules, with radiate, finely punctated striae. Between both valves and connected to the lower valve by some vertical processes, is an interior siliceous skeleton of more or less complicated structure.

1 *Campyloneis Grevillei* (SM.) GRUN.

1862, GRUNOW, p. 429.

1853—58, SMITH, Syn. I, p. 22, Pl. 3, f. 35, *Cocconeis Grevillei*.

1867, GRUNOW, p. 11.

1894—95, CLEVE, Syn. I, p. 167, *Campyloneis Grevillei* var. *typica*.

Valve broadly elliptical, with rounded ends. Upper valve with a depressed, lanceolate area. Striae 6 in 10  $\mu$ ; outside of the area composed of distinct puncta, inside of short ribs, formed of fused puncta. Lower valve with straight median line, not reaching the margin; with radiate striae, 12—14 in 10  $\mu$ , made up of coarse puncta, 12—15 in 10  $\mu$ . Interior skeleton of transverse ribs connected by an axial rib. Rare.

Length, 44  $\mu$ ; breadth, 31  $\mu$ .

Fig. 99 View of lower valve and interior skeleton. Length, 44  $\mu$ ;  
 breadth, 31  $\mu$ .  $\times$  1500.

(6) Genus *NAVICULA* BORY

Cells usually free, capable of movement. Often united into ribbon-like chains in plankton forms. Both valves with raphe and central nodule. Halves of the raphe not surrounded by an elevated parallel ridge; both ends of each half terminating in a rounded or elongated bead; central and



terminal nodules of valve surrounded or broadened transversally. Without a keel.

1 *Navicula Weissflogii* A. SCHMIDT

1873, p. 406, Pl. 6, f. 3, 4.  
Atlas, Pl. 12, f. 26-32.

Valve elliptical, strongly constricted in the center, segments sub-elliptical. Central nodule with approximate horns. Transverse costae 9—13 in 10  $\mu$ , crossed by numerous equidistant, straight, longitudinal costae, curved outwards in the middle of the valve. Not common. Given as *Diploneis Weissflogii* A. S. in CLEVE, Synopsis, I, p. 91.

Length, 24—40  $\mu$ ; breadth, 8—18  $\mu$ .

Fig. 100 Valve view. Length, 40  $\mu$ .  $\times$  1500.

2 *Navicula elliptica* KÜTZING

1844, p. 98, Pl. 30, f. 55.  
(See figure in SCHMIDT, Atlas, Pl. 7, f. 29).

Cell elliptical. Striae very distinct, about 13 in 10  $\mu$ , interrupted near center. Rare.

Length, 26  $\mu$ ; width, 12  $\mu$ .

Fig. 101 Valve. Length, 26  $\mu$ ; width, 12  $\mu$ .  $\times$  1500.

3 *Navicula Pelagi* A. SCHMIDT

1875, Atlas, Pl. 7, f. 26.

Valve rhombic-elliptical. Central nodule large, rounded, quadrate. Transverse costae coarse, very prominent, 9—10 in 10  $\mu$ , crossed by a longitudinal costa midway between center of valve and margin, giving the valve the appearance of being reticulated. Two to three longitudinal rows of minute puncta between costae of outer group. Rare. Given in CLEVE, Synopsis, I, p. 93, as *Diploneis fusca* GREG. var. *Pelagi* A. S.

Length, 40  $\mu$ ; breadth, 18  $\mu$ .

Fig. 102. Valve. Length, 40  $\mu$ ; breadth, 18  $\mu$ .  $\times$  1500.

(7) Genus PLEUROSIGMA W. SMITH

Cells free, elongated. Raphe strongly curved into an S, rarely into a C; sides of valve usually corresponding to the same curve. Marking uniform over entire valve, of fine, closely set lines, arranged either in two series, one transverse and one longitudinal, or in three series, one transverse and the other two at angles of 60° to each other. Tips of the raphe

turned to opposite sides of the valve. Both central and end nodules present.

The newer name, *Pleurosigma* W. SMITH (1853—56), has been used rather than the older one, *Gyrosigma* HASSAL (1845), only because of its more common acceptance. The latter, however, is preferable, and is apparently coming into more general use.

1 *Pleurosigma naviculaceum* BRÉB.

1854, p. 27, f. 7.

Valve lanceolate, gently sigmoid, with acute or slightly rostrate ends. Median line more sigmoid than the valve, excentric, prominent. Transverse and oblique striae equidistant. Rare.

Length, 79  $\mu$ ; breadth, 16  $\mu$ ; striae, 17—18 in 10  $\mu$ .

Fig. 103 Valve. Length, 79  $\mu$ ; breadth, 16  $\mu$ .  $\times$  750.

„ 103a Sculpturing of valve.  $\times$  1500.

2 *Pleurosigma pelagicum* PÉRAG.

1891, p. 7, Pl. 3, f. 3.

(See CLEVE, 1894, Synopsis, I, p. 37).

Valve not strongly sigmoid, lanceolate, acute. Median line strongly sigmoid. Not common.

Length, 194  $\mu$ ; breadth, 24  $\mu$ ; transverse and oblique striae, 18—21 in 10  $\mu$ .

Fig. 104 Valve. Length, 194  $\mu$ ; breadth, 24  $\mu$ .  $\times$  750.

„ 104a Sculpturing.  $\times$  1500.

3 *Pleurosigma elongatum* W. SM.

1852, p. 6, Pl. 1, f. 4.

1853, Synopsis, I, p. 64, Pl. 20, f. 199.

Valve lanceolate, flexure slight, extremities somewhat pointed. Raphe central, slightly sigmoid. Rare.

Length, 445  $\mu$ ; breadth, 36  $\mu$ ; transverse and oblique striae, 17—20 in 10  $\mu$ .

Fig. 105 Valve. Length, 445  $\mu$ ; breadth, 36  $\mu$ .  $\times$  325.

„ 105a Sculpturing.  $\times$  1500.

4 *Pleurosigma Normanii* RALFS

1861, in PRITCHARD, Infusoria, p. 919.

Valve gently sigmoid, lanceolate, with subacute ends. Median line gently sigmoid, central. Fairly common.

Length, 92—127  $\mu$ ; breadth, 12—24  $\mu$ ; striae, transverse 17—22, oblique 18—21 in 10  $\mu$ .

Fig. 106 Valve. Length, 127  $\mu$ ; breadth, 24  $\mu$ .  $\times$  750.

„ 106a Sculpturing of cell in fig. 106.  $\times$  1500.

„ 106b Another valve. Length, 92  $\mu$ ; breadth, 12  $\mu$ . Sculpturing indicated.  $\times$  1500.

#### 5 *Pleurosigma angulatum* W. SM.

1853, Synopsis I, p. 65, Pl. 21, f. 205.

Valve rhomboidal-lanceolate, slightly sigmoid, angular in the middle, ends somewhat acute. Raphe central, slightly sigmoid. Central nodulè small. Transverse and oblique striae equidistant. Not common.

Length, 110—115  $\mu$ ; breadth, 18—20  $\mu$ ; striae, 18—21 in 10  $\mu$ .

Fig. 107 Valve. Length, 111  $\mu$ ; breadth, 18  $\mu$ .  $\times$  750.

„ 107a Sculpturing.  $\times$  1500.

#### var. *strigosa* W. SM.

1853, Synopsis, I, p. 64, Pl. 21, f. 203, *Pleurosigma strigosum*.

VAN HEURCK, Synopsis, p. 115, Pl. 19, f. 2, *P. angulatum* var. *strigosa*.

Valve lanceolate, slightly sigmoid, gradually tapering to the sub-acute ends. Median line excentric, a little more sigmoid than the valve. Transverse and oblique striae equidistant. Not common.

Length, 269—338  $\mu$ ; breadth, 30  $\mu$ ; striae, 18—20 in 10  $\mu$ .

Fig. 108 Valve. Length, 338  $\mu$ ; breadth, 30  $\mu$ .  $\times$  325.

„ 108a Sculpturing.  $\times$  1500.

#### 6 *Pleurosigma aestuarii* W. SM. var.?

1853, Synopsis, I, p. 65, Pl. 31, f. 275.

Valve broadly lanceolate, gently sigmoid, with slightly rostrate ends. Median line more sigmoid than the valve, excentric. The identification of this species is not certain, but it seems most nearly allied to *P. aestuarii* of which it may be a small variety. Not common.

Length, 24—46  $\mu$ ; breadth, 8—14  $\mu$ ; transverse and oblique striae, 17—20 in 10  $\mu$ .

Fig. 109 Valve with sculpturing indicated. Length, 46  $\mu$ ; breadth, 14  $\mu$ .  $\times$  1500.

#### 7 *Pleurosigma Spencerii* W. SM.

1852, p. 12, Pl. 2, f. 15.

1853, Synopsis, I, p. 68, Pl. 22, f. 218.

Valve linear-lanceolate, sigmoid, with more or less obtuse ends. Median

line central, more or less excentric near extremities. Resembles most closely the figures of *P. Spencerii* var. *Arnottii* GRUN. (PÉRAGALLO, 1891, Pl. 8, f. 18—19; PÉRAGALLO, H. and M., 1897—1908, Pl. 34, f. 18). Rare.

Length, 123  $\mu$ ; breadth, 10  $\mu$ ; striae, longitudinal and transverse, 18—22 in 10  $\mu$ .

Fig. 110 Valve. Length, 122  $\mu$ ; breadth, 10  $\mu$ .  $\times$  750.

„ 110a Sculpturing.  $\times$  1500.

### 8 *Pleurosigma rectum* DONKIN

1858, p. 23, Pl. 3, f. 6.

Valve linear, straight, with obliquely rounded ends. Median line strongly excentric and sigmoid. Rare. Given in VAN HEURCK, Synopsis, as *Donkinia recta* (DONKIN) GRUN.

Length, 142  $\mu$ ; breadth, 12  $\mu$ ; longitudinal and transverse striae, 22 in 10  $\mu$ .

Fig. 111 Valve. Length, 142  $\mu$ ; breadth, 12  $\mu$ .  $\times$  750.

„ 111a Sculpturing.  $\times$  1500.

### 9 *Pleurosigma compactum* GREV.

1857, p. 12, Pl. 3, f. 9.

Synonyms: *Pleurosigma Smithianum* CASTR.

1886, p. 38, Pl. 28, f. 6.

*Rhoicosigma? Tahitense* (CASTR.) H. PÉRAG.

1891, p. 33, Pl. 10, f. 9.

Cell with dissimilar valves. Only lower valve observed here. Broadly lanceolate, not strongly sigmoid, gradually tapering to the more or less acute ends. Median line strongly excentric and sigmoid, rather abruptly crossing the valve near the center. Rare.

Length 281  $\mu$ ; breadth 62  $\mu$ ; striae, transverse 18—20 in 10  $\mu$ , longitudinal 20—24 in 10  $\mu$ .

Fig. 112 Lower valve. Length, 281  $\mu$ ; breadth, 62  $\mu$ .  $\times$  325.

„ 112a Sculpturing.  $\times$  1500.

## (8) Genus AMPHIPRORA EHRENBERG

Cells single or in ribbon-like chains. Valves with raphe, central nodule and keel which is twisted into an S, so that one half lies on each side of the chain axis. Valve lanceolate, acute, convex. Central area small or none. Structure of the lower part of the valve: transverse striae, rarely scattered puncta; structure of the keel: puncta in transverse or decussat-

ing rows. Connecting zone complex with more or less numerous, transversely striate divisions.

1 *Amphiprora gigantea* GRUN.

1860, p. 258, Pl. 6, f. 12.

var. *sulcata* (O'MEARA) CLEVE

1871, O'MEARA, p. 22, Pl. 3, f. 3, *Amphiprora sulcata*.

1894, CLEVE, Syn., Part I, p. 18.

Cell strongly constricted. Keel with a hyaline margin. Junction-line curved like a bow. Keel with puncta forming obliquely decussating rows, 13—15 in 10  $\mu$ . Striae of the valve curved, divergent from the central nodule, 13—14 in 10  $\mu$ , not decussating. Median line strongly sigmoid. Connecting zone with numerous longitudinal divisions. Striae on connecting zone, 20 in 10  $\mu$ . Rare.

Length, 97  $\mu$ .

Fig. 113 Girdle view. Length, 97  $\mu$ .  $\times$  750.

„ 113a Part of cell shown in Fig. 113, indicating structure.  
 $\times$  1500.

(9) Genus MASTOGLOIA THWAITES

Valves linear, lanceolate or orbicular, frequently with rostrate or capitate ends, symmetrical. Median line usually undulate. Axial area usually indistinct. Central area small. Structure: transverse punctate striae, usually subparallel, the puncta so disposed as to form obliquely decussating, or straight or undulating longitudinal, striae. Connecting zone not complex. Between the zone and the valve, a marginal septate plate.

1 *Mastogloia minuta* GREV.

1857, p. 12, Pl. 3, f. 10.

Cell elliptical-oval to elliptical-oblong. Extremities produced, almost knob-like. Median line straight. Conspicuously apiculate; loculi 9—12; punctation very fine, in optical section striae almost perpendicular to median line, 24—26 in 10  $\mu$ ; near surface striae more radial, puncta coarser about 20 in 10  $\mu$ . Not common.

Length of cell, 18—20  $\mu$ ; width, 8—10  $\mu$ .

Fig. 114 Valve view. Focus slightly above optical. Length, 20  $\mu$ ;  
width, 10  $\mu$ .  $\times$  1500.

„ 114a Same cell as in Fig. 114. Focus optical. Puncta indicated  
on part of valve.  $\times$  1500.

## (10) Genus AMPHORA EHRENBERG

Both valves similar and asymmetrical along the longitudinal axis. Ventral and dorsal sides in planes crossing each other at an angle, which is variable. No transverse ribs. Raphe evident, much nearer the concave side of the valve than the median line. Zone wide, composed of several bands, punctated. Cell usually broadly elliptical with truncate ends. Valves lunate, acute. Central nodule transversely dilated to a stauros or not.

1 *Amphora lineolata* (EHR.) GRUN.

1838a, EHRENBERG, p. 188, n. 250, Pl. 14, f. 4, *Navicula lineolata*.

1880—85, GRUNOW in VAN HEURCK, Syn. p. 57, Pl. 1, f. 23.

var. *chinensis* (A. SCHM.) CLEVE

1875, SCHMIDT, Atlas, Pl. 26, f. 42, *Amphora chinensis*.

1895, CLEVE, Syn., Part. II, p. 126.

Cell elliptical with broad, truncate ends and convex margins; membranaceous. Zone with numerous divisions, 12—14 in 10  $\mu$ , very finely, transversely striated. Central nodule slightly transversely dilated. Dorsal part of valve finely striated; striae 20—22 in 10  $\mu$ . Striations made up of fine puncta. Rare.

Length, 40  $\mu$ ; breadth, 20  $\mu$ .

Fig. 115 Girdle view. Length, 40  $\mu$ ; breadth, 20  $\mu$ .  $\times$  1500.

2 *Amphora decussata* GRUN.

1867, p. 178, Pl. 195, f. 9.

Cell thin, elliptical with truncate ends; a little over twice as long as broad. Zone with numerous divisions. Central nodule dilated into a transverse stauros. Dorsal side with very oblique striae, about 15—17 in 10  $\mu$ , turned in opposite directions from the stauros and crossed by undulating, narrow, transverse, blank bands. Ventral side very narrow, striated, 14—15 striae in 10  $\mu$ . Rare.

Length, 106  $\mu$ ; breadth, 42  $\mu$ .

Fig. 116 Girdle view. Length, 106  $\mu$ ; breadth, 42  $\mu$ .  $\times$  750.

„ 116a, b Parts of cell shown in Fig. 116.  $\times$  1500.

## (11) Genus BACILLARIA GMELIN

Cells rod-like. United in movable bands. Valves slightly convex. Keel median or almost median. Keel puncta not extended laterally. Transverse striae distinct.

1 *Bacillaria paradoxa* GMEL

1880—1885, VAN HEURCK, Synopsis, Pl. 61, f. 6, 7.

Cells rod-like, united in movable colonies. In girdle view narrow rectangular, in valve view linear lanceolate, with pointed ends. Common.

Length of valve, 156—246  $\mu$ ; breadth, 6  $\mu$  in girdle view, 8—11 in valve view; striae 20—21 in 10  $\mu$ .

Fig. 117 Colony of 9 cells. Girdle view. Length of valve, 164  $\mu$ ; breadth, 6  $\mu$ .  $\times$  325.

„ 117a End of two cells in girdle view.  $\times$  1500.

„ 117b Extremities of a cell in valve view. Length, 246  $\mu$ ; breadth, 11  $\mu$ ;  $\times$  1500.

## (12) Genus NITZSCHIA HASSAL

Cells spindle-shaped, single or united in colonies. Valves with raphe but no central nodule. The keels of the two valves diagonally opposite. Sagittal section asymmetrical, transverse section rhombic. Valves in transverse direction symmetrical with a keel and keel puncta which are short or extended into short ribs.

1 *Nitzschia panduriformis* GREG.

1857, p. 57, Pl. 6, f. 102.

var. *continua* GRUN.

In VAN HEURCK's Synopsis, p. 172, Pl. 58, f. 6.

Cell elliptical, constricted in the center, extremities slightly pointed. Large hyaline puncta on margin, about 9 in 10  $\mu$ . Extremely fine punctation on valves, 25—27 puncta in 10  $\mu$ , arranged in a three line system, difficult to see. Not common.

Length, 17  $\mu$ ; breadth, 7  $\mu$ .

Fig. 118 Valve. Length, 17  $\mu$ ; breadth, 7  $\mu$ .  $\times$  1500.

2 *Nitzschia sigma* W. SM.

1853—56, Vol. I, p. 39, Pl. 13, f. 108.

Valves linear, a little sigmoid, gradually diminishing in size toward the extremities.

var. *intercedens* GRUN.

See VAN HEURCK Syn., p. 179, Pl. 66; f. 1.

Length, 330  $\mu$ ; breadth, 10  $\mu$ ; coarse striae, 6—7 in 10  $\mu$ . Not common.

- Fig. 119 Girdle view. Length, 330  $\mu$ ; breadth, 10  $\mu$ .  $\times$  160.  
 „ 119a Extremities of same cell.  $\times$  325.

var. *indica* KARSTEN

1907, p. 400, Pl. 54, f. 11a, b.

Considerably diminished in size at extremities. In girdle view S-shaped; in valve view straight or slightly S-shaped.

Length, 520  $\mu$ ; breadth, 12  $\mu$ ; coarse striae 7—10 in 10  $\mu$ . Rare.

- Fig. 120 Girdle view. Length 520  $\mu$ ; breadth 12  $\mu$ .  $\times$  160.  
 „ 120a Extremities of same cell.  $\times$  325.

3 *Nitzschia longissima* (BRÉB.) RALFSS.

1861, in PRITCHARD, p. 783.

Cells living singly, motile. Central enlarged area lanceolate. Ends hair-like, greatly elongated, nearly straight. Common.

Length, 253  $\mu$ ; breadth, 6  $\mu$ ; puncta, 5—7 in 10  $\mu$ .

- Fig. 121 Entire cell. Length, 253  $\mu$ ; breadth, 6  $\mu$ .  $\times$  325.  
 „ 121a Extremity of cell in fig. 121.  $\times$  1500.  
 „ 121b Section near center of same cell.  $\times$  1500.  
 „ 121c Central part of same cell.  $\times$  750.

4 *Nitzschia Closterium* W. SM.

1853—56, p. 42, Pl. 15, f. 120.

Cells living singly, motile. Central enlarged region elliptical-lanceolate. Ends hair-like, usually more or less curved. Possibly a variety of *N. longissima*. Common.

Length, 57—208  $\mu$ ; breadth, 5—12  $\mu$ ; puncta 15 in 10  $\mu$ .

- Fig. 122 Entire cell. Length, 115  $\mu$ ; breadth, 7  $\mu$ .  $\times$  750.  
 „ 122a Another cell. Length, 208  $\mu$ ; breadth, 12  $\mu$ .  $\times$  325.  
 „ 122b Central part of cell shown in fig. 122.  $\times$  1500.  
 „ 122c, d Two smaller cells. Length, 122c, 60  $\mu$ ; 122d, 57  $\mu$ .  
 $\times$  750.

5 *Nitzschia Lorenziana* GRUNOW

1880, CLEVE and GRUNOW, p. 101.

var. *incurva* GRUNOW

1880, CLEVE and GRUNOW, p. 102.

Small. Valve, narrow, lanceolate, gradually diminished toward extremities, slightly sigmoid. Resembles a small form of *N. sigma*, but differs in structure of valve. Not common.



Length, 79—140  $\mu$ ; breadth, 6  $\mu$ ; striae, 14—15 in 10  $\mu$ .

Fig. 123 Girdle view. Length, 79  $\mu$ ; breadth, 6  $\mu$ .  $\times$  750.

„ 123a Another cell, girdle view. Length, 140  $\mu$ ; breadth, 6  $\mu$ .  
 $\times$  325.

„ 123b Extremities of cell in fig. 123 a.  $\times$  750.

#### 6 *Nitzschia seriata* CLEVE

1883, p. 478, Pl. 38, f. 75.

Cells spindle-shaped or fusiform, with more or less pointed ends. United in stiff, hair-like chains in such a way that the cells lie together for a short distance along their points. Common.

Length, 97—174  $\mu$ ; breadth, 6—8  $\mu$ ; striae, 10—13 in 10  $\mu$ .

Fig. 124 Three cells in a chain. Length of cell, 97  $\mu$ .  $\times$  325.

„ 124a Two longer cells in a chain. Length of cell, 174  $\mu$ .  $\times$  325.

### (13) Genus *SURIRELLA* TURPIN

Cells single. Valves wedge-shaped, oval, elliptical or linear, sometimes twisted. With a longitudinal, central, linear or lanceolate pseudoraphe, and margins produced into a wing-like expansion containing the raphe on each side. Pseudoraphes of the two valves parallel. Distinct canal-pores usually visible. Valve marked with transverse ribs not quite extending to the center. Valve surface nearly flat.

#### 1 *Surirella gemma* EHR.

1838b, p. 76, Pl. 4, f. 5.

Valve elliptical to ovate; in front view somewhat wedge-shaped. Ribs or canaliculi linear, very narrow, irregularly spaced, 2—4 in 10  $\mu$ , reaching the median line which is also narrow. Marginal alae indistinct. Surface of valve striated with very fine, transverse striae made up of tiny puncta visible only under high magnification, 18—21 striae in 10  $\mu$ . Very rare. Littoral.

Length, 102  $\mu$ .

Fig. 125 Valve view. Striae indicated on section of valve. Length, 102  $\mu$ .  $\times$  750.

#### 2 *Surirella fluminensis* GRUN.

1862, p. 463.

(See SCHMIDT, Atlas, Pl. 4, f. 9).

Valve ovate. Front view more or less wedge-shaped. Ribs or canaliculi

few, about 10, inflated toward the margin, reaching narrow median canal (except last pair). Marginal striae delicate, 18—20 in 10  $\mu$ . Possibly a variety of *S. fastuosa* EHR. Rare.

Length, 44—56  $\mu$ ; width, 28—36  $\mu$ .

Fig. 126 Valve view. Length, 56  $\mu$ ; width, 36  $\mu$ .  $\times$  1500.

(14) Genus **CAMPYLODISCUS** EHRENBERG

Cells single. Valve outline nearly circular; ribs or other markings radial. Valve surface saddle-shaped, rarely almost flat. Keel not winged. Valves with a longitudinal central pseudoraphe, that of one valve at right angles to that of the other. Canal pores distinct, usually in parallel rows.

1 *Campylodiscus* (?) *cocconeiformis* GRUNOW

(CLEVE and MÖLLER, Diat. no. 178 and 214).

In CLEVE, 1883, p. 502, Pl. 38, f. 78.

Cell only slightly longer than broad. Entire valve areolated. Row of large areoles around margin; smaller, more or less irregular on rest of valve, diminishing in size toward center; in 13—21 sectors. Rare.

Length, 25—30  $\mu$ ; breadth, 20—26  $\mu$ .

Fig. 127 Valve view. Length, 28  $\mu$ ; breadth, 24  $\mu$ .  $\times$  1500.

## LITERATURE CITED

- Baily, J. W. (1842) — American Bacillariae. Part. II: Naviculaceae. Amer. Journ. Sci., vol. 42.
- — (1851) — Microscopical observations made in South Carolina, Georgia and Florida. Smithson. Contr. Knowl., vol. 2, art. 8, Washington.
- — (1856) — On microscopic forms in the Sea of Kamschatka. Amer. Journ. Sci. and Arts, ser. 2, vol. 22, New Haven.
- Boyer, C. S. (1900) — The biddulphoid forms of North American Diatomaceae. Proc. Acad. Philadelphia, pp. 685—748.
- Brébisson, A. de (1854) — Note sur quelques Diatomées marines rares ou peu connues, du littoral de Cherbourg. Mém. Soc. Sci. Nat. Cherb., T. 2, pp. 241—258.
- — (1857) — Description de quelques nouvelles Diatomées observées dans le guano du Pérou, formant le genre *Spatangidium*. Bull. Soc. Linn. Norm., T. 2.
- Brightwell, T. (1856) — On the filamentous long-horned Diatomaceae. Quart. Journ. Micr. Sci., vol. 4, London.
- — (1858) — Remarks on the genus *Rhizosolenia* of Ehrenberg. Quart. Journ. Micr. Sci., vol. 6, London.
- — (1859—1860) — On some of the rarer or undescribed species of Diatomaceae, Parts I, II. Quart. Journ. Micr. Sci., vol. 7. 8. London.
- Brun, J. (1891) — Diatomées, espèces nouvelles marines, fossiles ou pélagiques, Mém. Soc. Phys. et Hist. Nat. Genève, T. 31, No. 1.
- Castracane, F. (1886) — Report on the Diatomaceae collected by H.M.S. "Challenger" during the years 1873—76. Rept. of the "Challenger" Exp., Botany, vol. 2.
- Cleve, P. T. (1873a) — Examination of Diatoms found on the surface of the Sea of Java. Bih. t. K. Svenska Vet.-Ak. Handl., Bd. 1, No. 11, Stockholm.
- — (1873b) — On Diatoms from the Arctic Sea. Bih. t. K. Svenska Vet.-Ak. Handl., Bd. 1, No. 13, Stockholm.
- — (1878) — Diatoms from the West Indian Archipelago. Bih. t. K. Svenska Vet.-Ak. Handl., Bd. 5, No. 8, Stockholm.
- — (1881) — On some new and little-known Diatoms. K. Svenska Vet.-Ak. Handl., Bd. 18, No. 5, Stockholm.
- — (1883) — Diatoms collected during the expedition of the "Vega". "Vega" Exp. Vetensk. Iaktt., Bd. 3, Stockholm.
- — (1889) — Pelagiske Diatomeer från Kattegat. Det Videnskabelige Udbytte af Kanonbaaden „Hauch's" Togter i de Danske Have, Hft. I, Copenhagen.
- — (1894) — Planktonundersökningar. Cilioflagellater og Diatomaceer. Bih. t. k. Svenska Vet.-Ak. Handl., Bd. 20, Afd. 3, No. 2, Stockholm.
- — (1894—1895) — Synopsis of the naviculoid Diatoms. K. Svenska Vet.-Ak. Handl., Bd. 26, No. 2; Bd. 27, No. 3.
- — (1897) — A treatise on the phytoplankton of the northern Atlantic and its tributaries. Upsala.
- — (1900a) — Plankton from the southern Atlantic and the southern Indian Ocean. Öfversigt af Kongl. Vetenskaps-Akademiens Förhandlingar, No. 8, Stockholm.

- Cleve, P. T. (1900b) — Plankton from the Red Sea. Översigt af Kongl. Vetenskaps-Akademiens Förhandlingar, No. 9.
- — (1901) — Plankton from the Indian Ocean and the Malay Archipelago. Kongl. Svenska Vetenskaps-Akademiens Handlingar, Bd. 35, No. 5.
- — and Grunow, A. (1880) — Beiträge zur Kenntnis der Arktischen Diatomeen. K. Svenska Vet.-Ak. Handl., Bd. 17, No. 2.
- — and Möller, J. D. (1877—82) — Diatoms, Parts I—VI. Uusala.
- Donkin, A. S. (1858) — On the marine Diatomaceae of Northumberland, with a description of eighteen new species. Trans. Micr. Soc. Lond., n.s. vol. 6, pp. 12—34.
- Ehrenberg, C. G. (1838a) — Die Infusionsthierchen als vollkommene Organismen. Ein Blick in das tiefere organische Leben der Natur. Leipzig, Leopold Voss.
- — (1838b) — Ueber die Bildung der Kreidefelsen und des Kreidemergels durch unsichtbare Organismen. Phys. Abh. Akad. Wiss., Berlin, pp. 59—147 (1840).
- — (1839) — Ueber noch jetzt zahlreich lebende Thierarten der Kreidebildung und den Organismus der Polythalmien. Phys. Abh. Akad. Wiss., Berlin (1841).
- — (1841) — Verbreitung und Einfluss des mikroskopischen Lebens in Süd- und Nord-Amerika. Phys. Abh. Akad. Wiss., Berlin, pp. 291—446 (1843).
- — (1844) — Mittheilung über zwei neue Lager von Gebirgsmassen aus Infusorien als Meeres-absatz in Nord-Amerika und eine Vergleichung derselben mit den organischen Kreidegebilden in Europa und Afrika. Ber. Akad. Wiss., Berlin, 1844 (1845).
- — (1845) — Neue Untersuchungen über das kleinste Leben als geologisches Moment. Ber. Akad. Wiss., Berlin, pp. 53—87 (1846).
- — (1854) — Mikrogeologie. Leipzig, Leopold Voss.
- Forti, A. (1922) — Ricerche su la flora pelagica (fitoplankton) di Quarto dei Mille (Mare Ligure). R. Com. Talass. It. Lab. Mar. di quarto dei Mille Presso Genova, Mem. XCVII.
- Gran, H. H. (1897) — Protophyta: Diatomaceae, Silico-flagellata and Cilioflagellata. Den Norske Nordhavs Expedition 1876—78, h. 24.
- — (1904) — Die Diatomeen der Arktischen Meere. I. Teil: Die Diatomeen des Planktons. Fauna Arctica, Bd. 3, Lief. 3, Jena.
- — (1905) — Nordisches Plankton, XIX, Diatomeen, Kiel und Leipzig.
- — (1915) — The plankton production of the north European waters in the spring of 1911. Bull. Plank., p. l'année 1912, Copenhagen.
- — and Yendo, K. (1914) — Japanese Diatoms: I. On Chaetoceras; II. On Stephanopyxis. Vid. Skrift. I. Mat.-Naturv. Klasse. 1913, No. 8, Christiania.
- Gregory, W. (1857) — On new forms of marine Diatomaceae, found in the Firth of Clyde and in Loch Fine. Trans. Roy. Soc. Edinb., vol. 21.
- Greville, R. K. (1857) — Description of some new diatomaceous forms from the West Indies. Quart. Journ. Micr. Sci., vol. 5, London.
- — (1859) — Descriptions of Diatomaceae observed in Californian guano. Quart. Journ. Micr. Sci., vol. 7, London.
- — (1862) — Descriptions of new and rare Diatoms. Series VII. Quart. Journ. Micr. Sci., n.s., vol. 2.
- — (1864) — Descriptions of new species of Diatoms from the South Pacific, Part III. Trans. Bot. Soc. Edinburgh, vol. 8.
- — (1865a) — Descriptions of new and rare Diatoms. Series XIV—XVII. Trans. Micr. Soc. London, n.s., vol. 13.
- — (1865b) — Descriptions of new genera and species of Diatoms from Hongkong. Ann. & Mag. Nat. Hist., vol. 16, ser. 3, no. 91, July, 1865.

- Greville, R. K. (1866) — Descriptions of new and rare Diatoms. Ser. XVIII—XX. Trans. Micr. Soc. London, vol. 14.
- Grunow, A. (1860) — Ueber neue oder ungenügend bekannte Algen. Erste Folge. Diatomaceen, Familie Naviculaceen. Verhandl. d. K. K. Zool. Bot. Gesellsch., Bd. 10, Vienna.
- — (1862) — Die österreichischen Diatomeen. Verhandl. d. K. K. Zool. Bot. Gesellsch., Bd. 12, Vienna.
- — (1863) — Ueber einige neue und ungenügend bekannte Arten und Gattungen von Diatomaceen. Verhandl. d. K. K. Zool. Bot. Gesellsch., Bd. 13, Vienna.
- — (1867) — Nachträgliche Bemerkungen über die von Herrn Lindig gesammelten Diatomeen von Honduras. Hedwigia, Bd. 6, Dresden.
- — (1868) — Reise seiner Majestät Fregatte Novara um die Erde. Bot. Theil, Bd. 1, Vienna.
- — (1879) — New species and varieties of Diatomaceae from the Caspian Sea. Jour. Roy. Micr. Soc., vol. 2.
- — (1884) — Die Diatomeen von Franz-Josefs-Land. Denkschr. d. Kais. Ak. d. Wissensch., Math.-Naturw. Klasse, Bd. 48, Vienna.
- Hensen, V. (1887) — Ueber die Bestimmung des Plankton. 5. Bericht der Kommission zur wissenschaftlichen Untersuchung der Deutschen Meere bei Kiel für die Jahre 1882—86. Kiel.
- Hustedt, F. (1927—1930) — Die Kieselalgen Deutschlands, Österreichs und der Schweiz mit Berücksichtigung der übrigen Länder Europas sowie der angrenzenden Meeresgebiete. Dr. L. Rabenhorsts Kryptogamen-Flora von Deutschland, Österreich und der Schweiz. VII. Band. Teil I. Lieferung 1—5. Akad. Verlags-Gesellschaft m. b. H. Leipzig.
- Ikari, Jiro. (1927) — On Bacteriastrum of Japan. Bot. Mag., vol. 41, no. 486, Tokyo.
- Janisch, C. (1891) — The Diatoms of the Gazelle Expedition. 22 pl. photographs with manuscript index.
- Karsten, G. (1907) — Das Indische Phytoplankton. Wiss. Ergebn. d. deutsch. Tiefsee Exp. auf dem Dampfer „Valdivia“, Bd. 2, Teil 2, Lief. 3.
- Kützing, F. T. (1844) — Die kieselschaligen Bacillarien oder Diatomeen, Nordhausen.
- Lauder, H. S. (1864) — (a) On New Diatoms. (b) Remarks on the marine Diatomaceae found at Hong-Kong, with descriptions of new species, with notes by J. Ralfs. Trans. Micro. Soc., n.s., vol. 12, London.
- Lebour, Marie V. (1930) — The planktonic Diatoms of northern seas. Ray Society, London.
- Leuduger-Fortmorel, G. M. D. (1892) — Diatomées de la Malaisie. Annales du Jard. Bot. de Buitenzorg, T. 11.
- Mangin, L. (1910) — Sur quelques algues nouvelles ou peu connues du Phytoplankton de l'Atlantique. Bull. Soc. Bot. France, T. 57, Paris.
- — (1917) — Sur le Chaetoceros criophilus, espèce caractéristique des mers antarctiques. C. R. Acad. Sci., T. 164, 1917, pp. 704 et 770.
- — (1919) — Sur les Chaetoceros du groupe Peruvianus Bgtw. Bull. Mus. Nat. d'Hist. Nat., T. 25, pp. 305 et 411.
- Mann, A. (1907) — Report on the Diatoms of the „Albatrosse“ voyages in the Pacific Ocean, 1888—1904. Contrib. U. S. Nat. Herbar., vol. 10, Part 5.
- Meunier, A. (1910) — Microplancton des Mers de Barents et de Kara. Duc d'Orléans, Campagne Arctique de 1907, Brussels.
- — (1913) — Microplancton de la mer Flamande. I Partie: Le genre Chaetoceros Ehrh. Mém. Mus. R. Hist. Nat. Belgique, T. 7, fasc. 2, Brussels.
- — (1915) — Microplancton de la mer Flamande. II Partie: Les Diatomacées. Mém. Mus. R. Hist. Nat. Belgique, T. 7, fasc. 3, Brussels.

- Okamura, K. (1907) — Some Chaetoceras and Peragallia of Japan. Bot. Mag., vol. 21, Tokyo.
- — (1911) — Some littoral Diatoms of Japan. Rept. Imp. Fish. Inst., vol. 7, Tokyo.
- O'Meara, E. (1871) — On some new species of the g. Amphora. Quart. Journ. Micro. Sci., vol. 11.
- Ostenfeld, C. H. (1900) — Plankton in 1899. Iagttagelser over Overfladevandets Temperatur, Saltholdighed og Plankton paa islandske og grønlandske Skibrouter i 1899, udgivne af Martin Knudsen og C. Ostenfeld.
- — (1902) — Marine plankton Diatoms. Johs. Schmidt: Flora of Koh Chang, Part 7 (Reprinted from Botanisk Tidsskrift, Bd. 25), Copenhagen.
- — (1903) — Phytoplankton from the sea around the Faroes. Botany of the Faroes, vol. 2, Copenhagen.
- — (1915) — A list of phytoplankton from the Boeton Strait, Celebes. Dansk. Bot. Arkiv., Bd. 2, No. 4, Note, Copenhagen.
- — and Schmidt, Johs. (1901) — Plankton fra det Røde Hav og Adenbugten (Plankton from the Red Sea and the Gulf of Aden). Vidensk. Meddel. fra den naturhistoriske Forening i Kjøbenhavn for Aaret, 1901.
- Pavillard, J. (1913) — Observations sur les Diatomées, 2e série. Bull. Soc. Bot. France, T. 60, Paris.
- — (1916) — Recherches sur les Diatomées pélagiques du Golfe de Lion. Trav. de l'Inst. Bot. de Univ. de Montpellier, Mém. 5. Cette.
- — (1924) — Observations sur les Diatomées, 4e série. Le genre Bacteriastrium. Bull. Soc. Bot. France, T. 71, Paris.
- — (1925) — Bacillariales. Rept. on the Danish Oceanographical Expedition 1908—10 to the Mediterranean and Adjacent Seas, vol. 2, Biology, J. 4.
- Péragallo, H. (1888) — Diatomées de la baie de Villefranche (Alpes-Maritimes). Bull. d'Hist. Nat. de Toulouse, T. 22, Paris.
- — (1891) — Monographie du genre Pleurosigma et des genres alliés. Le Diatomiste, T. 1, pp. 1—35.
- — (1892) — Monographie de Rhizosolenia et de quelques genres voisins. Le Diatomiste, T. 1, Paris.
- — (1897—1908) — Diatomées marines de France et des districts maritimes voisins. Grez-sur-Loing.
- Pritchard, A. (1861) — A history of the Infusoria. London.
- Ratray, J. (1890) — A revision of the genus Coscinodiscus Ehrb. and some allied genera. Proc. Roy. Soc. Edinburgh, vol. 16.
- Schmidt, A. Ueber Navicula Weissflogii und Navicula Gründleri. Zeitschr. f. ges. Naturwiss. Bd. 41, pp. 403—410.
- — (1873—1928) — Atlas der Diatomaceenkunde, in Verbindung mit den Herren Gründler, Grunow, Janisch, Weissflog und Witt herausgegeben. Aschersleben.
- Schröder, B. (1900) — Das Phytoplankton des Golfes von Neapel. Mitt. a. d. Zool. Stat. z. Neapel, Bd. 14, Berlin.
- — (1906) — Beiträge zur Kenntnis des Phytoplanktons warmer Meere. Vierteljahrschr. d. naturforsch. Ges. in Zürich, Jahrg. 51. Zürich.
- Schultze, M. (1858) — Innere Bewegungserscheinungen bei Diatomeen der Nordsee aus den Gattungen Coscinodiscus, Denticella, Rhizosolenia. Müller's Archiv, 1858 (Summary also in Quart. Journ. Micro. Sci., vol. 7, 1859, London).
- Schütt, F. (1893) — Das Pflanzenleben der Hochsee. Kiel und Leipzig.
- — (1895) — Arten von Chaetoceras und Péragallia. Ein Beitrag zur Hochseeflora. Ber. D. deutsch. Bot. Gesellsch., Bd. 13, Berlin.

- Schütt, F. (1896) — Bacillariales. Engler-und Prantl: Die Natürlichen Pflanzenfamilien, I Teil, Abt. 1b. Leipzig.
- Smith, Rev. William (1852) — Notes on the Diatomaceae; with descriptions of British species included in the genus Pleurosigma. Ann. Mag. Nat. Hist. II, vol. 9, pp. 1—12.
- — (1853—1856) — A synopsis of the British Diatomaceae, vol. I—II. London, Smith and Beck.
- Van Heurck, H. (1880—85) — Synopsis des Diatomées de Belgique. Anvers.
- Wallich, G. C. (1860) — On the siliceous organisms in the digestive cavities of the Salpae. Trans. Micro. Soc. n.s., vol. 8. London.
- Wildeman, E. de. (1897) — Prodrome de la flore algologique des Indes Néerlandaises. Batavia.
- Wolle, Francis. (1894) — Diatomaceae of North America. Bethlehem, Pa. The Comenius Press.
-

## INDEX TO GENERA AND SPECIES

	Figure	Page
<i>Actinoptychus</i> EHRENBERG . . . . .		120
— <i>undulatus</i> (BAIL.) RALFS . . . . .	20	120
<i>Amphiprora</i> EHRENBERG . . . . .		158
— <i>gigantea</i> GRUN. var. <i>sulcata</i> (O'MEARA) CLEVE . . . . .	113	159
<i>Amphora</i> EHRENBERG . . . . .		160
— <i>decussata</i> GRUN. . . . .	116	160
— <i>lineolata</i> (EHR.) GRUN. var. <i>chinensis</i> (A. SCHMIDT) CLEVE . . . . .	115	160
<i>Asterionella</i> HASSAL . . . . .		153
— <i>japonica</i> CLEVE . . . . .	98	154
<i>Asterolampra</i> EHRENBERG . . . . .		121
— <i>marylandica</i> EHR. . . . .	21	121
<i>Asteromphalus</i> EHRENBERG . . . . .		121
— <i>Cleveanus</i> GRUNOW . . . . .	23	122
— <i>flabellatus</i> (BRÉB.) GREVILLE . . . . .	22	122
<i>Bacillaria</i> GMELIN . . . . .		160
— <i>paradoxa</i> GMEL. . . . .	117	161
<i>Bacteriastrum</i> SHADBOLT . . . . .		131
— <i>comosum</i> PAVILLARD . . . . .	50	132
— <i>delicatulum</i> CLEVE . . . . .	46	131
— <i>hyalinum</i> LAUDER . . . . .	47	131
— <i>varians</i> LAUDER . . . . .	48	132
— — var. <i>hispida</i> (CASTR.) SCHRÖDER . . . . .	49	132
<i>Bellerochea</i> VAN HEURCK . . . . .		143
— <i>malleus</i> (BRIGHTWELL) VAN HEURCK form <i>biangulata</i> HUSTEDT . . . . .	78	144
<i>Biddulphia</i> GRAY . . . . .		145
— <i>dubia</i> (BRIGHTWELL) CLEVE . . . . .	84	147
— <i>heteroceros</i> GRUNOW . . . . .	82	146
— <i>mobiliensis</i> (BAIL.) GRUNOW . . . . .	80	145
— <i>reticulum</i> (EHR.) BOYER . . . . .	83	146
— <i>sinensis</i> GREVILLE . . . . .	81	146
— <i>species</i> . . . . .	85	147
<i>Campylodiscus</i> EHRENBERG . . . . .		164
— (?) <i>cocconeiformis</i> GRUNOW . . . . .	127	164
<i>Campyloneis</i> GRUNOW . . . . .		154
— <i>Grevillei</i> (SM.) GRUNOW . . . . .	99	154
<i>Cerataulina</i> H. PÉRAGALLO . . . . .		148
— <i>Bergonii</i> H. PÉRAG. . . . .	86	148
— <i>compacta</i> OSTENFELD . . . . .	87	149
<i>Chaetoceras</i> EHRENBERG . . . . .		133
— <i>affine</i> LAUDER . . . . .	66	139
— <i>breve</i> SCHÜTT . . . . .	70	140
— <i>coarctatum</i> LAUDER . . . . .	52	134
— <i>compressum</i> LAUDER . . . . .	60	137



	Figure	Page
<i>Chaetoceras constrictum</i> GRAN . . . . .	64 . . .	138
— <i>denticulatum</i> LAUDER . . . . .	53 . . .	134
— <i>didymum</i> EHRENBERG . . . . .	61 . . .	137
— — var. <i>anglica</i> (GRUN.) GRAN . . . . .	63 . . .	138
— — var. <i>protuberans</i> (LAUDER) GRAN & YENDO . . . . .	62 . . .	138
— <i>distans</i> CLEVE . . . . .	68 . . .	140
— <i>diversum</i> CLEVE . . . . .	71 . . .	141
— <i>Eibenii</i> GRUNOW . . . . .	51 . . .	134
— <i>laciniosum</i> SCHÜTT . . . . .	69 . . .	140
— <i>laeve</i> LEUDIGER-FORTMOREL . . . . .	72 . . .	141
— <i>Lauderii</i> RALFS . . . . .	59 . . .	137
— <i>Lorenzianum</i> GRUNOW . . . . .	58 . . .	136
— <i>nanodenticulatum</i> OKAMURA . . . . .	54 . . .	135
— <i>paradoxum</i> CLEVE . . . . .	67 . . .	139
— <i>peruvianum</i> BRIGHTWELL . . . . .	56 . . .	135
— — form <i>robusta</i> (CLEVE) HUSTEDT . . . . .	57 . . .	136
— <i>pseudocurvisetum</i> MANGIN . . . . .	73 . . .	141
— <i>rostratum</i> LAUDER . . . . .	55 . . .	135
— <i>Van Heurckii</i> GRAN . . . . .	65 . . .	138
<i>Climacodium</i> GRUNOW . . . . .		142
— <i>Frauenfeldianum</i> GRUNOW . . . . .	76 . . .	143
<i>Corethron</i> CASTRACANE . . . . .		122
— <i>criophilum</i> CASTR. . . . .	24 . . .	122
<i>Coscinodiscus</i> EHRENBERG . . . . .		113
— <i>asteromphalus</i> EHR. . . . .	14 . . .	118
— <i>concinus</i> W. SM. . . . .	12 . . .	116
— <i>excentricus</i> EHR. . . . .	5 . . .	113
— <i>gigas</i> EHR. var. <i>praetexta</i> (JANISCH) HUSTEDT . . . . .	16 . . .	118
— <i>Janischii</i> A. SCHMIDT var. <i>arafurensis</i> GRUNOW . . . . .	17 . . .	119
— <i>Jonesianus</i> (GREV.) OSTENFELD . . . . .	10 . . .	115
— — var. <i>commutata</i> (GRUN.) HUSTEDT . . . . .	11 . . .	116
— <i>lineatus</i> EHR. . . . .	6 . . .	114
— <i>marginatus</i> EHR. . . . .	7 . . .	114
— <i>nobilis</i> GRUNOW . . . . .	13 . . .	117
— <i>nodulifer</i> SCHMIDT . . . . .	9 . . .	115
— <i>oculus-iridis</i> EHR. . . . .	15 . . .	118
— <i>radiatus</i> EHR. . . . .	8 . . .	115
— <i>subtilis</i> EHR. . . . .	18 . . .	120
<i>Coscosira</i> GRAN . . . . .		113
— <i>Oestrupii</i> OSTENFELD . . . . .	4 . . .	113
<i>Ditylum</i> L. BAILEY . . . . .		144
— <i>sol</i> GRUNOW . . . . .	79 . . .	144
<i>Eucampia</i> EHRENBERG . . . . .		142
— <i>cornuta</i> (CLEVE) GRUNOW . . . . .	75 . . .	142
— <i>zodiacus</i> EHR. . . . .	74 . . .	142
<i>Guinardia</i> H. PÉRAGALLO . . . . .		124
— <i>flaccida</i> (CASTR.) PÉRAGALLO . . . . .	28 . . .	124
<i>Hemiaulus</i> EHRENBERG . . . . .		149
— <i>indicus</i> KARSTEN . . . . .	89 . . .	150

	Figure	Page
<i>Hemiaulus membranaceus</i> CLEVE . . . . .	90 . . .	150
— <i>sinensis</i> GREVILLE . . . . .	88 . . .	149
<i>Hemidiscus</i> WALLICH . . . . .		151
— <i>Hardmanianus</i> (GREV.) MANN . . . . .	91 . . .	151
<i>Lauderia</i> CLEVE . . . . .		123
— <i>annulata</i> CLEVE . . . . .	25 . . .	123
<i>Leptocylindrus</i> CLEVE . . . . .		124
— <i>danicus</i> CLEVE . . . . .	27 . . .	124
<i>Licmophora</i> AGARDH . . . . .		151
— <i>Lyngbyei</i> (KÜTZ.) GRUNOW . . . . .	92 . . .	152
<i>Mastogloia</i> THWAITES . . . . .		159
— <i>minuta</i> GREV. . . . .	114 . . .	159
<i>Navicula</i> BORY . . . . .		154
— <i>elliptica</i> KÜTZ . . . . .	101 . . .	155
— <i>Pelagi</i> A. SCHMIDT . . . . .	102 . . .	155
— <i>Weissflogii</i> A. SCHMIDT . . . . .	100 . . .	155
<i>Nitzschia</i> HASSAL . . . . .		161
— <i>Closterium</i> W. SM. . . . .	122 . . .	162
— <i>longissima</i> (BRÉB.) RALFS . . . . .	121 . . .	162
— <i>Lorenziana</i> GRUN. var. <i>incurva</i> GRUN. . . . .	123 . . .	162
— <i>panduriformis</i> GREG. var. <i>continua</i> GRUN. . . . .	118 . . .	161
— <i>seriata</i> CLEVE . . . . .	124 . . .	163
— <i>sigma</i> W. SM. var. <i>indica</i> KARSTEN . . . . .	120 . . .	162
— — var. <i>intercedens</i> GRUN. . . . .	119 . . .	161
<i>Paralia</i> HEIBERG . . . . .		111
— <i>sulcata</i> (EHR.) CLEVE . . . . .	1 . . .	112
<i>Planktoniella</i> SCHÜTT . . . . .		120
— <i>sol</i> (WALLICH) SCHÜTT . . . . .	19 . . .	120
<i>Pleurosigma</i> W. SM. . . . .		155
— <i>aestuarii</i> W. SM. . . . .	109 . . .	157
— <i>angulatum</i> W. SM. . . . .	107 . . .	157
— — var. <i>strigosa</i> W. SM. . . . .	108 . . .	157
— <i>compactum</i> GREV. . . . .	112 . . .	158
— <i>elongatum</i> W. SM. . . . .	105 . . .	156
— <i>naviculaceum</i> BRÉB. . . . .	103 . . .	156
— <i>Normanii</i> RALFS . . . . .	106 . . .	156
— <i>pelagicum</i> PÉRAG. . . . .	104 . . .	156
— <i>rectum</i> DONKIN . . . . .	111 . . .	158
— <i>Spencerii</i> W. SM. . . . .	110 . . .	157
<i>Raphoneis</i> EHRENBERG . . . . .		152
— <i>amphiceros</i> EHR. . . . .	93 . . .	152
— <i>surirella</i> (EHR ?) GRUN. . . . .	94 . . .	152
<i>Rhizosolenia</i> (EHRENBERG) BRIGHTWELL . . . . .		125
— <i>alata</i> BRIGHTWELL form <i>genuina</i> GRAN . . . . .	43 . . .	130
— — form <i>gracillima</i> (CLEVE) GRUNOW . . . . .	44 . . .	130
— — form <i>indica</i> (PÉRAG.) OSTENFELD . . . . .	45 . . .	130
— <i>arafurensis</i> CASTRACANE . . . . .	33 . . .	127
— <i>Bergonii</i> H. PÉRAGALLO . . . . .	32 . . .	126
— <i>calcar-avis</i> M. SCHULTZE . . . . .	41 . . .	129

	Figure	Page
<i>Rhizosolenia Clevei</i> OSTENFELD . . . . .	34	127
— <i>cylindrus</i> CLEVE . . . . .	30	126
— <i>hebetata</i> (BAIL.) GRAN emend. form <i>semispina</i> (HENSEN) GRAN	42	129
— <i>imbricata</i> BRIGHTWELL . . . . .	35	127
— — var. <i>Shrubsolei</i> (CLEVE) SCHRÖDER . . . . .	36	128
— <i>robusta</i> NORMAN . . . . .	31	126
— <i>setigera</i> BRIGHTWELL . . . . .	37	128
— <i>Stolterfothii</i> H. PÉRAGALLO . . . . .	29	125
— <i>styliformis</i> BRIGHTWELL . . . . .	38	128
— — var. <i>latissima</i> BRIGHTWELL . . . . .	40	129
— — var. <i>longispina</i> HUSTEDT . . . . .	39	129
<i>Schröderella</i> PAVILLARD . . . . .		123
— <i>delicatula</i> (PÉRAG.) PAVILLARD . . . . .	26	123
<i>Skeletonema</i> GREVILLE . . . . .		112
— <i>costatum</i> (GREV.) CLEVE . . . . .	3	113
<i>Stephanopyxis</i> EHRENBERG . . . . .		112
— <i>Palmeriana</i> (GREV.) GRUNOW . . . . .	2	112
<i>Streptotheca</i> SHRUBSOLE . . . . .		143
— <i>indica</i> KARSTEN . . . . .	77	143
<i>Surirella</i> TURPIN . . . . .		163
— <i>fluminensis</i> GRUNN . . . . .	126	163
— <i>gemma</i> EHR. . . . .	125	163
<i>Thalassiothrix</i> CLEVE and GRUNOW . . . . .		152
— <i>elongata</i> GRUNOW . . . . .	95	152
— <i>Frauenfeldii</i> (GRUN.) CLEVE and GRUNOW . . . . .	97	153
— <i>Nitzschioides</i> GRUNOW . . . . .	96	153

FIGURES 1-127



1

2

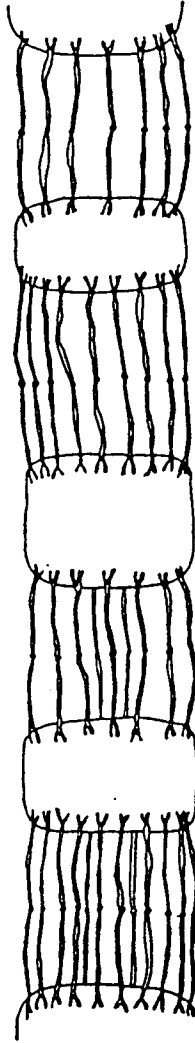
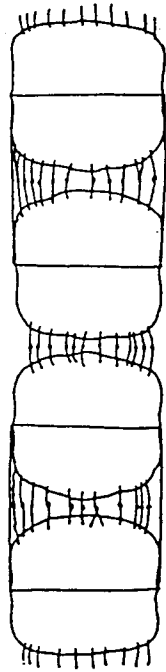

3

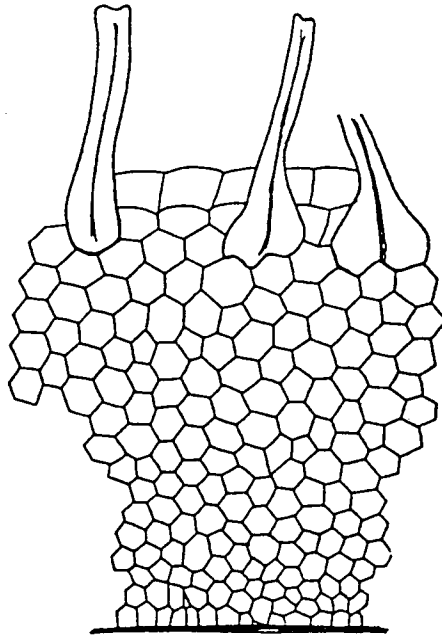

2a

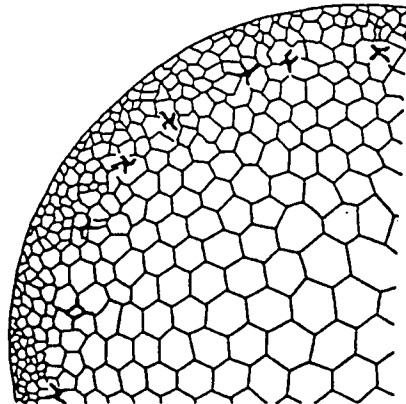

2b

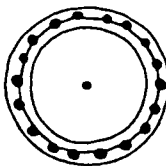

3a

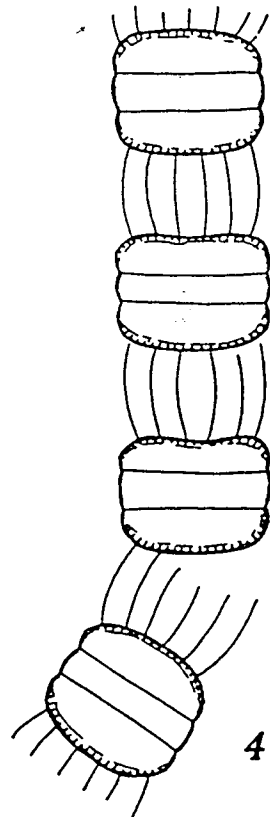

4

Figs. 1—4. 1. *Paralia sulcata*; 2. *Stephanopyxis Palmeriana*; 3. *Skeletonema costatum*; 4. *Coscinosira Oestrupii*.

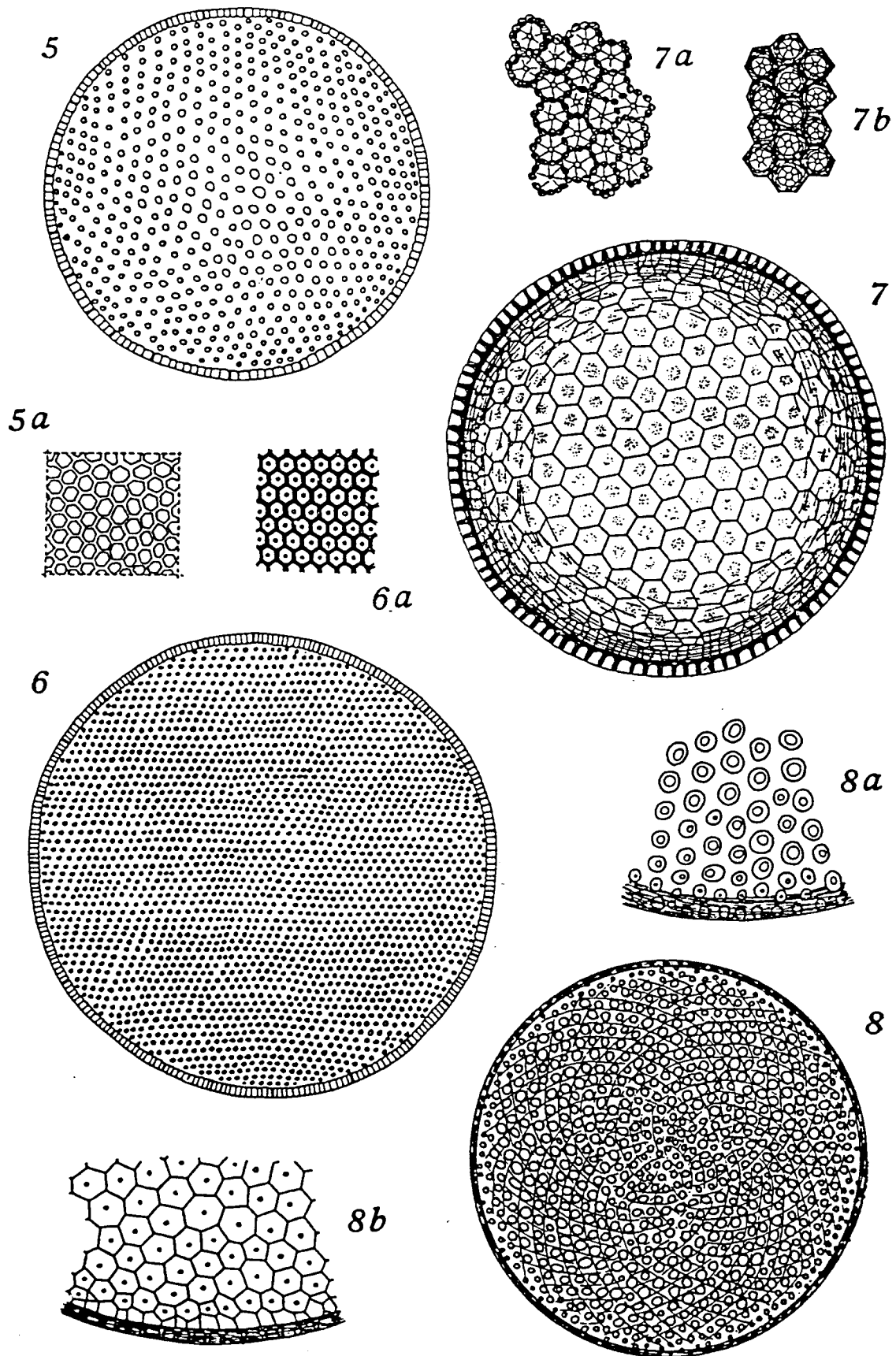

Figs. 5—8. 5. *Coscinodiscus excentricus*; 6. *Cosc. lineatus*; 7. *Cosc. marginatus*; 8. *Cosc. radiatus*.

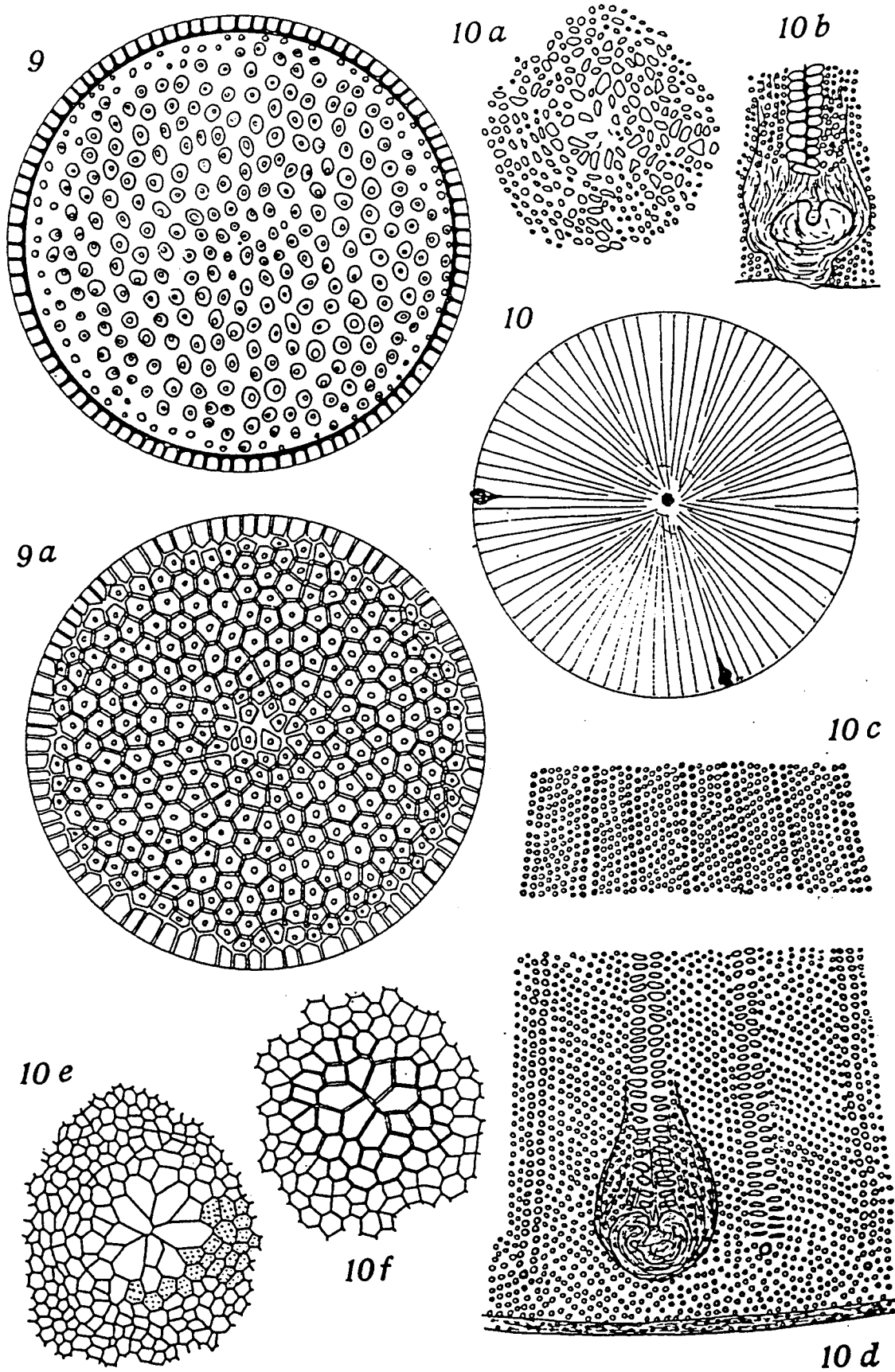

Figs. 9—10. 9. *Coscinodiscus nodulifer*; 10. *Cosc. Jonesianus*.

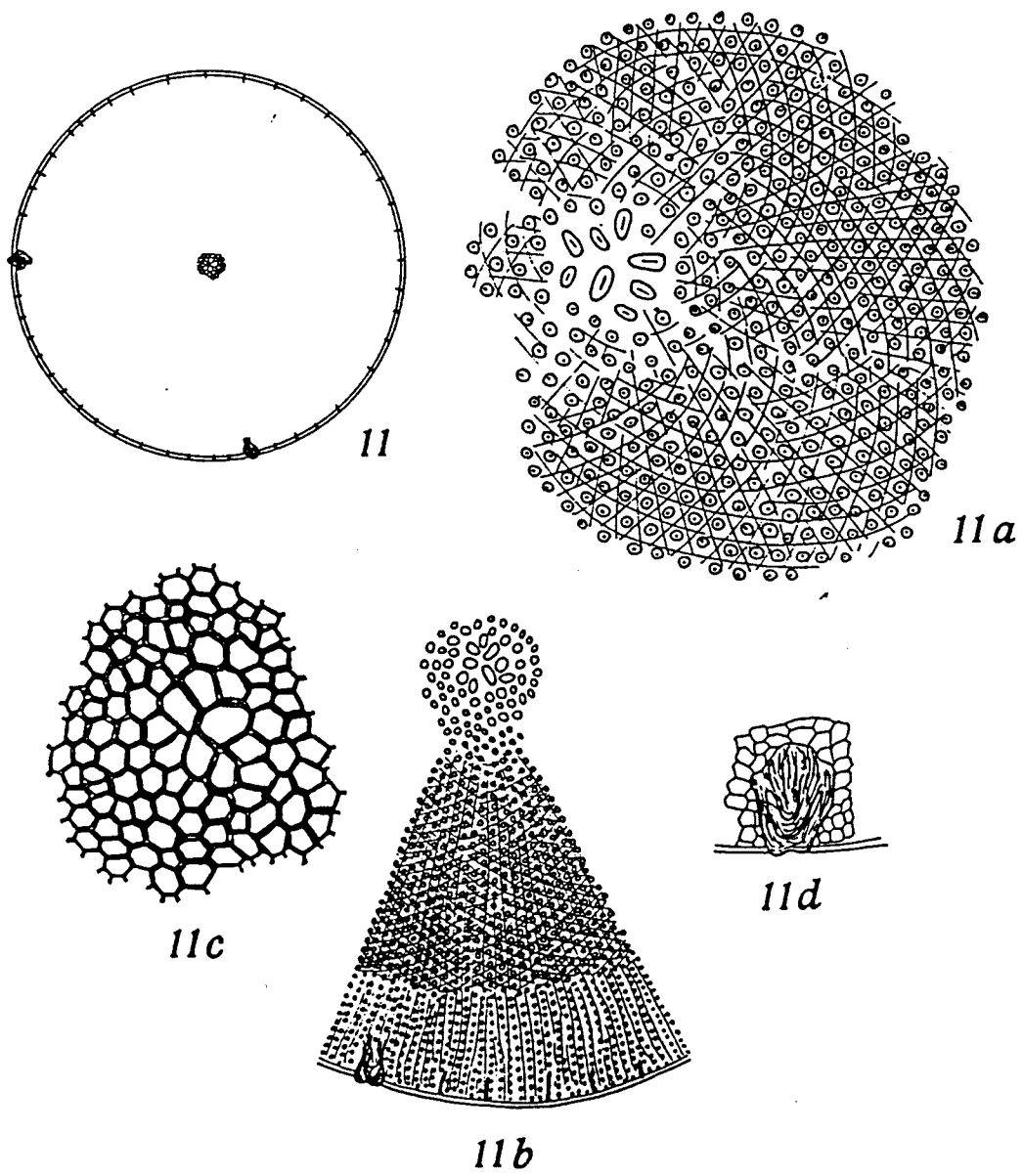
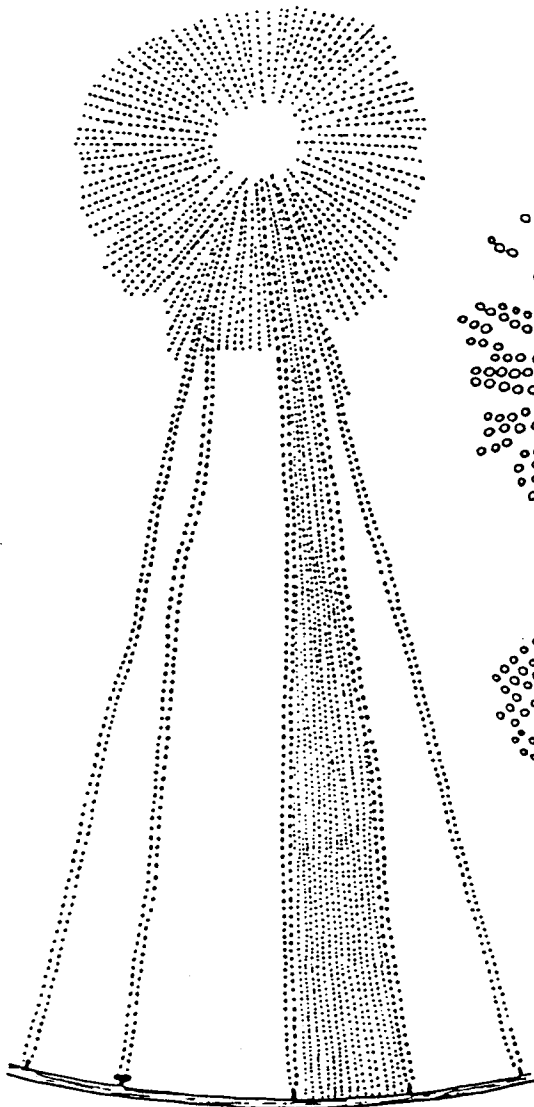
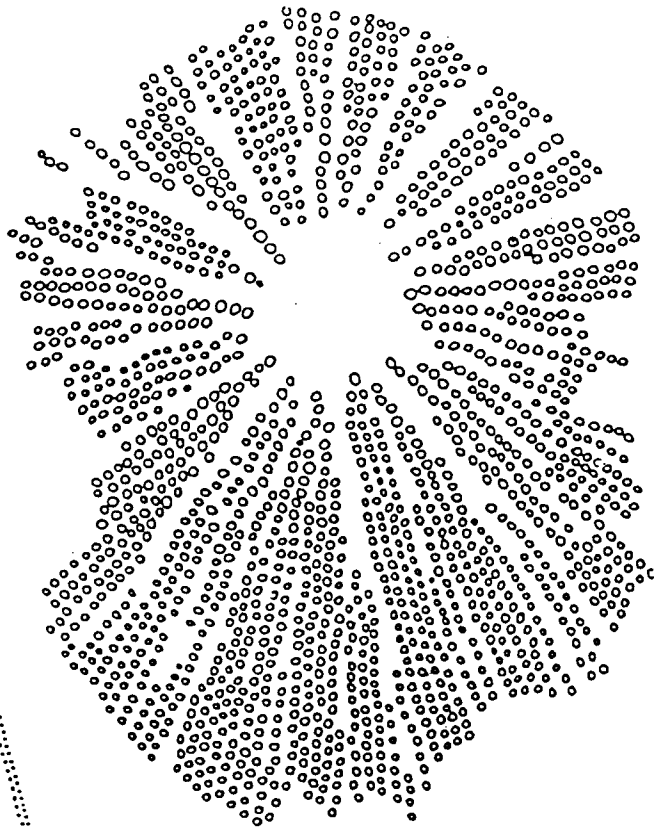

Fig. 11. *Coscinodiscus Jonesianus* var. *commutata*.





12a



12b

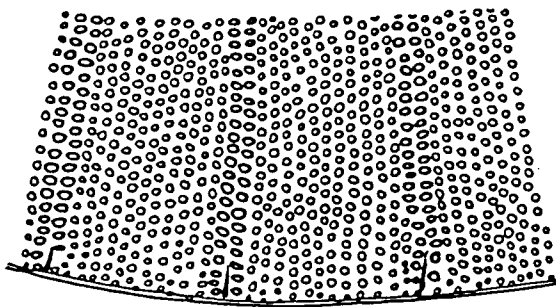

12c

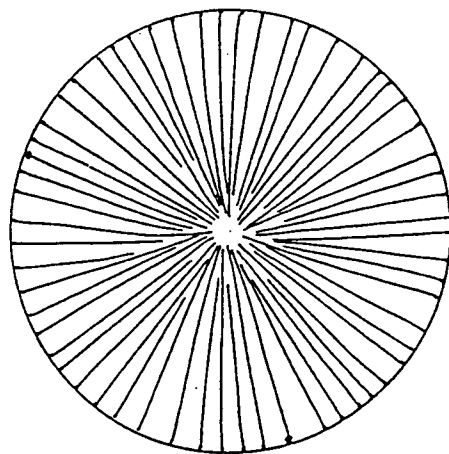

12

Fig. 12. *Coscinodiscus concinnus*.

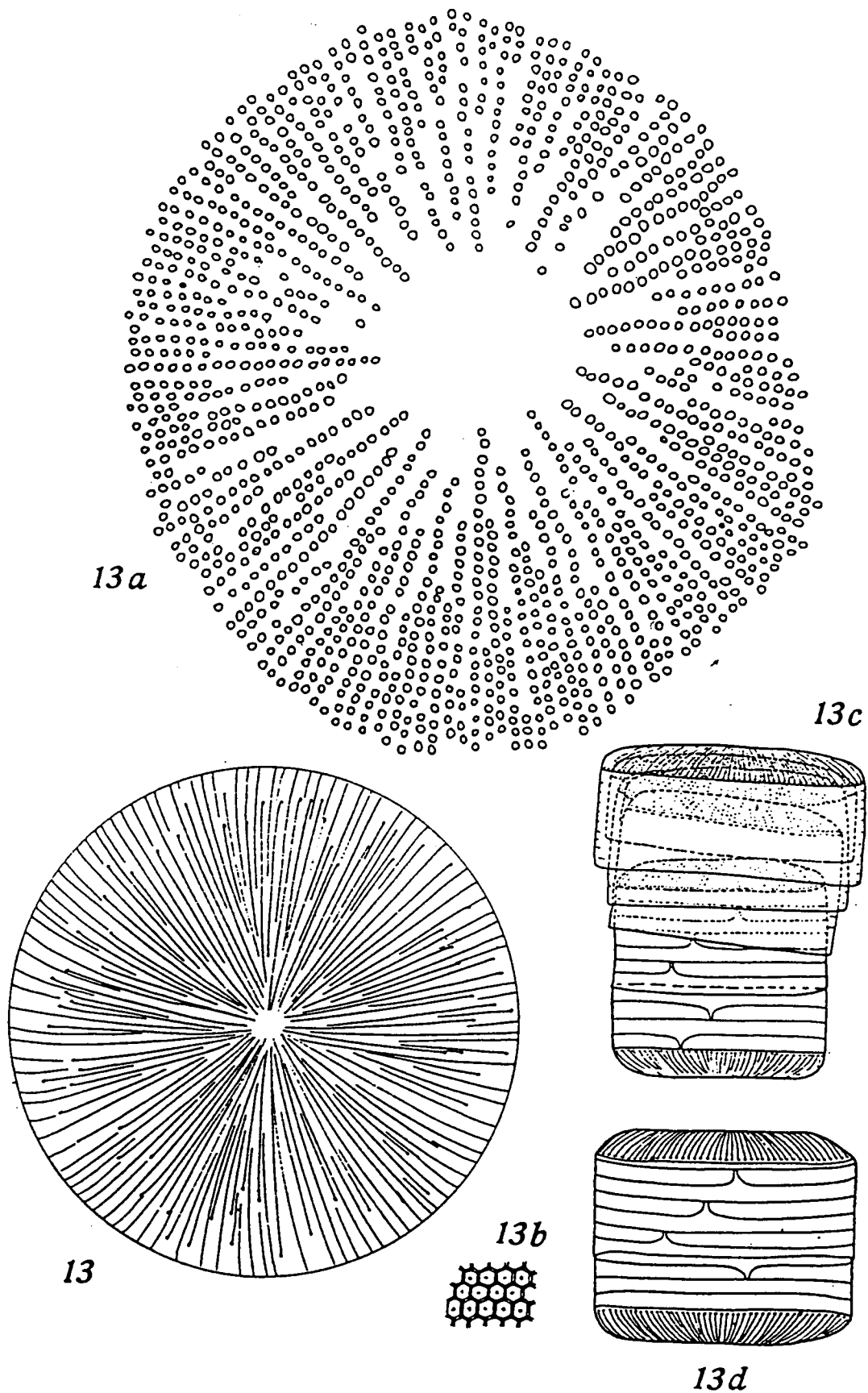
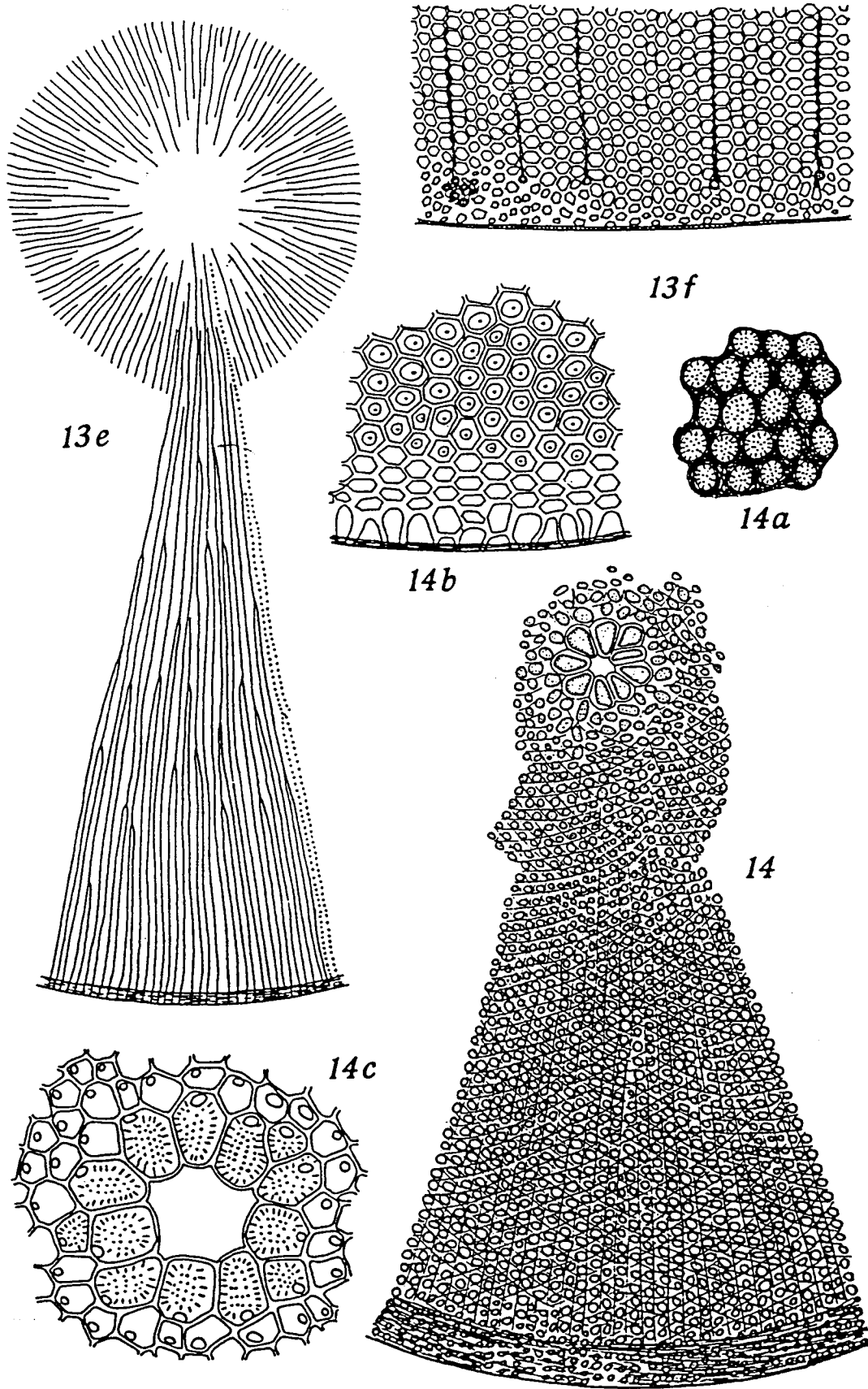

Fig. 13—13d. *Coscinodiscus nobilis*.



Figs. 13e-f; 14. 13e-f. *Coscinodiscus nobilis*; 14. *Cosc. asteromphalus*.

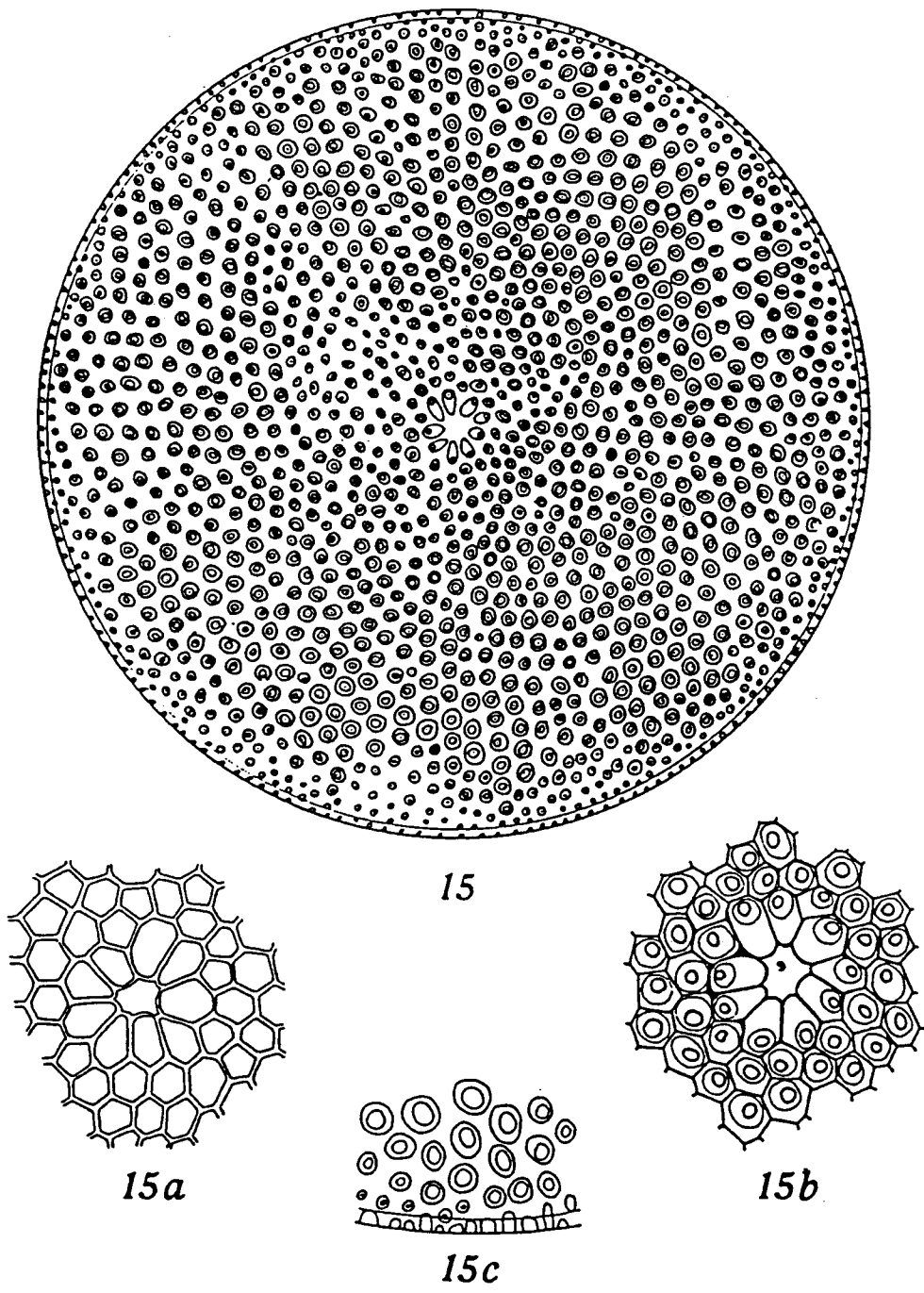
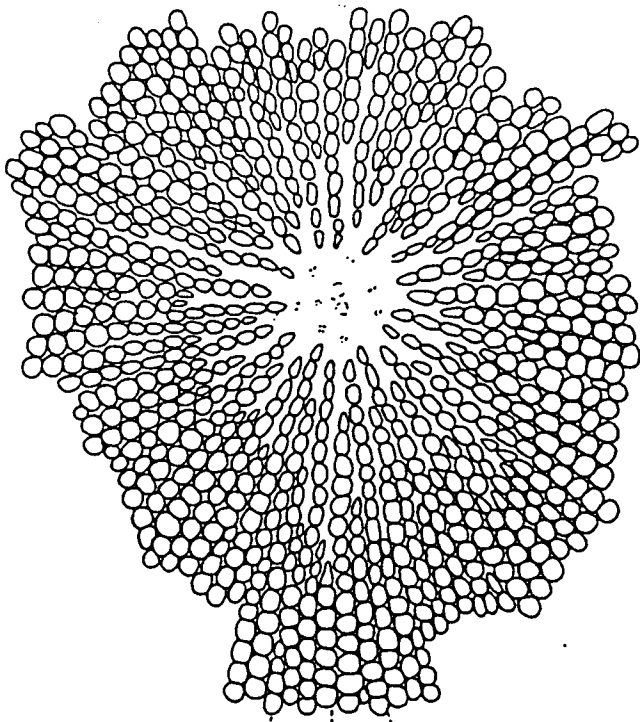
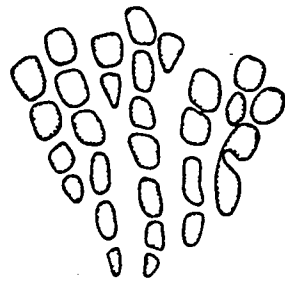

Fig. 15. *Coscinodiscus oculus-iridis*.



16



16a

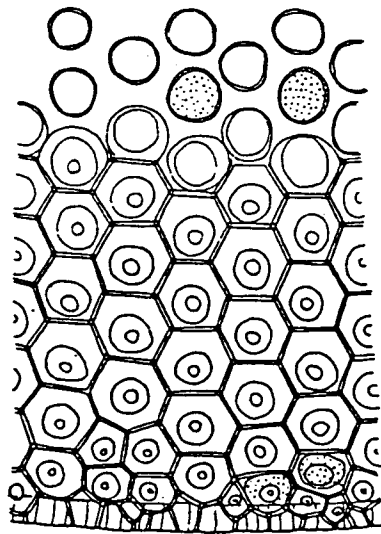
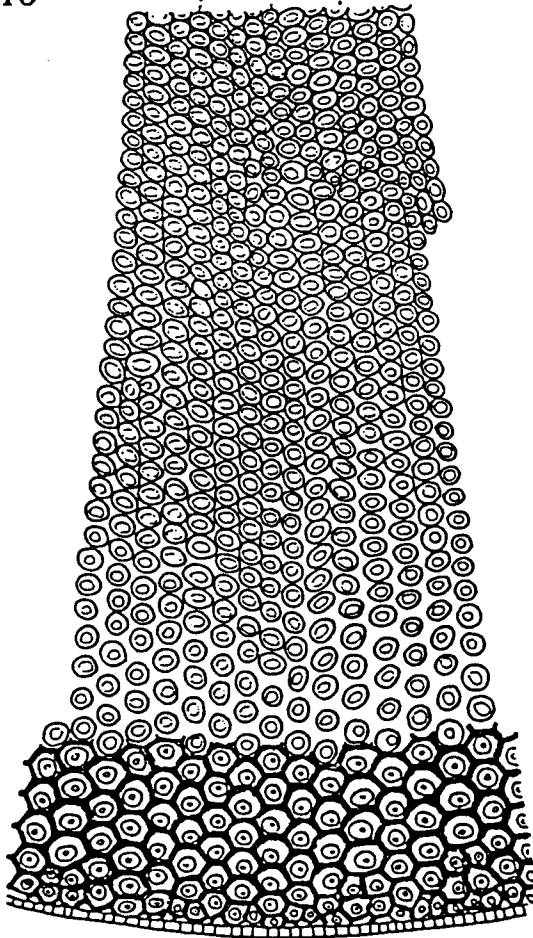

16b

Fig. 16. *Coscinodiscus gigas* var. *praetexta*.

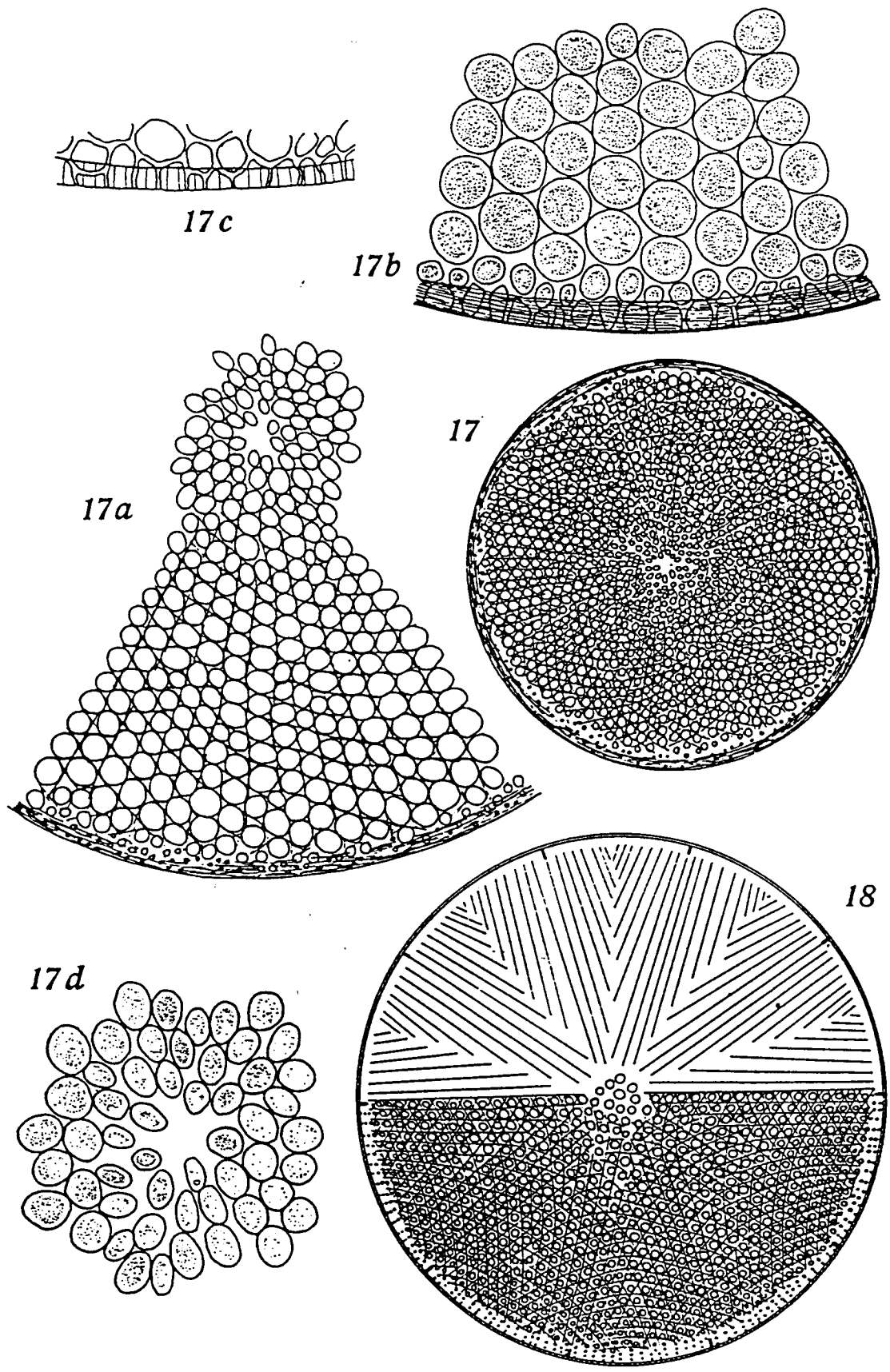

Figs. 17—18. 17. *Coscinodiscus Janischii* var. *arafurensis*; 18. *Cosc. subtilis*.

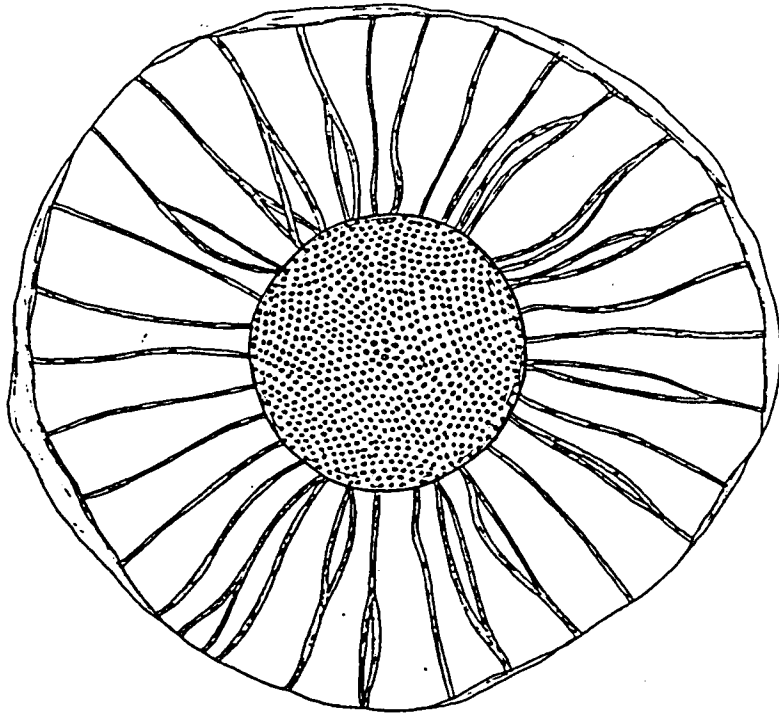

19

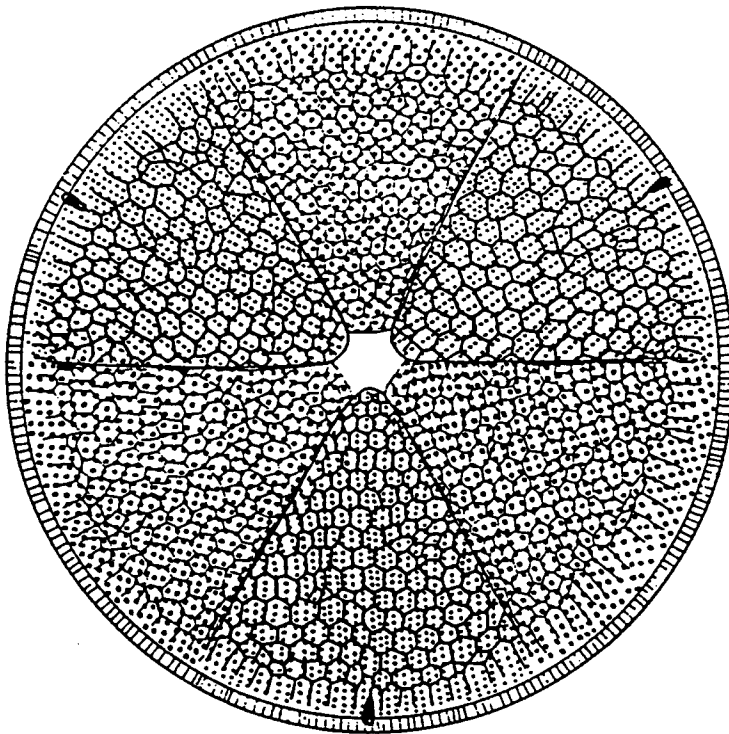

20

Figs. 19—20. 19. *Planktoniella sol*; 20. *Actinoptychus undulatus*.

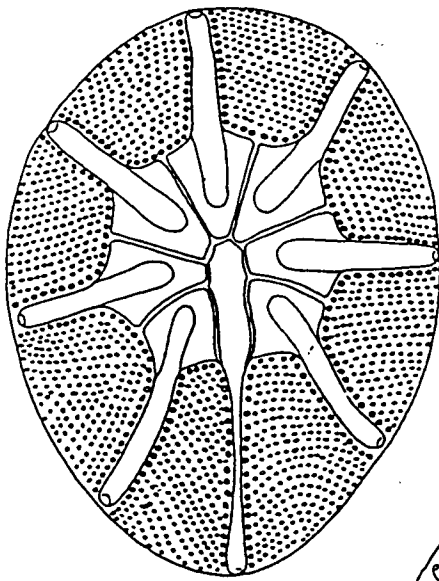

22

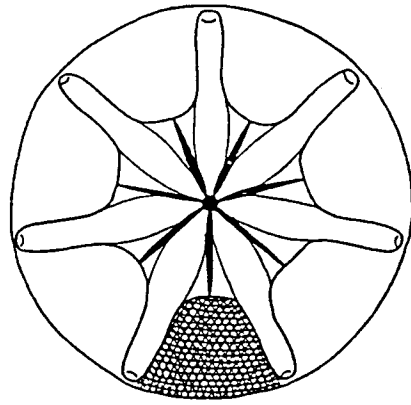

21

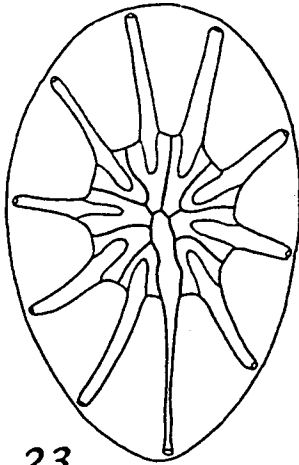

23

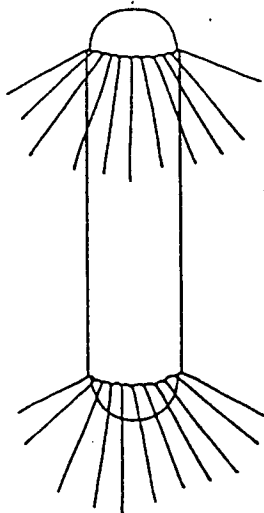

24

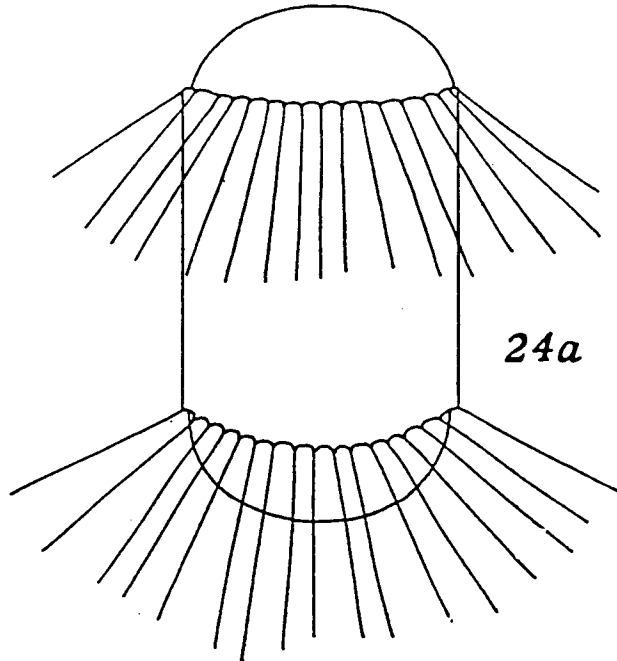

24a

Figs. 21—24. 21. *Asterolampra marylandica*; 22. *Asteromphalus flabellatus*; 23. *Asteromphalus Cleveanus*; 24. *Corethron criophilum*.



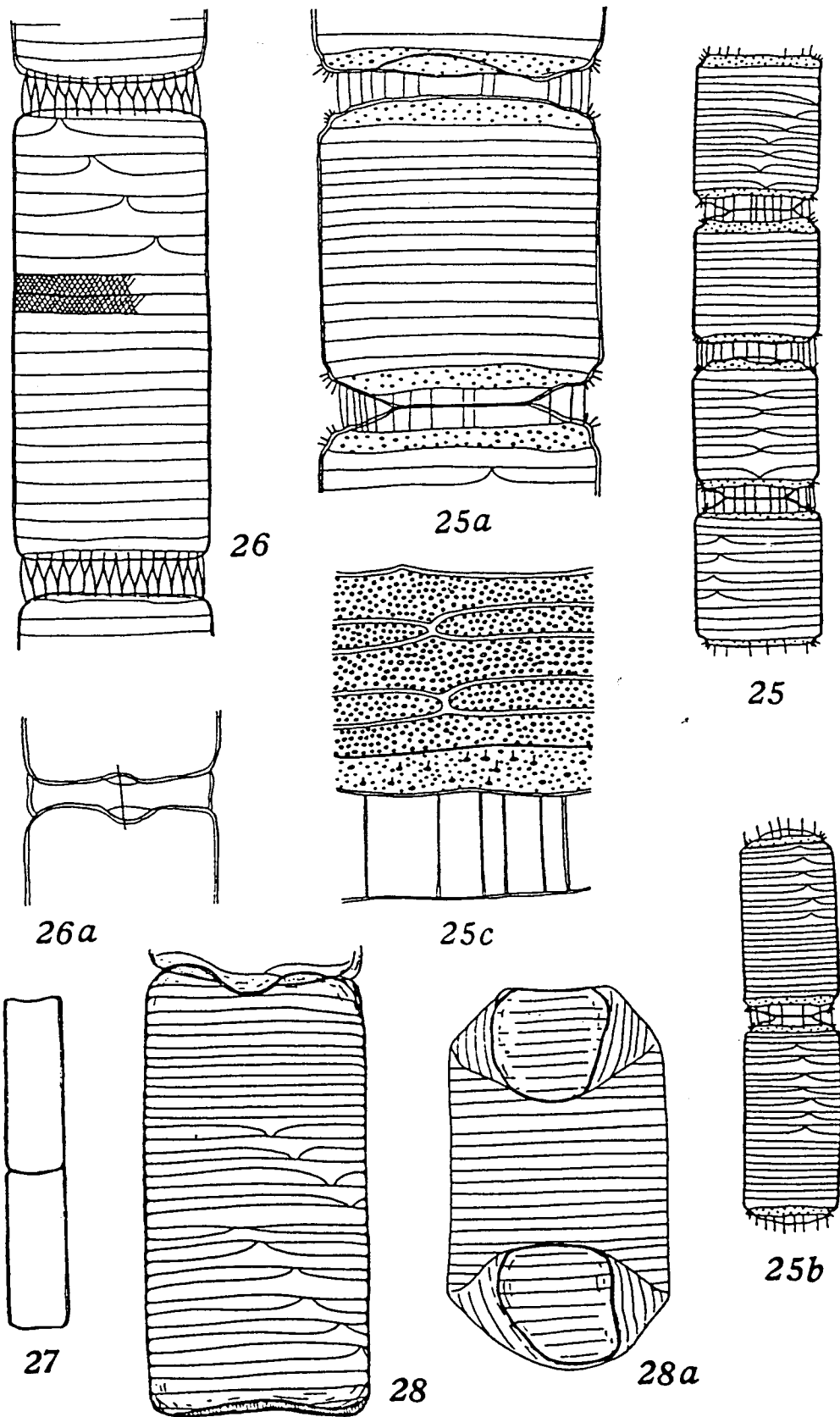

Figs. 25—28. 25. *Lauderia annulata*; 26. *Schröderella delicatula*; 27. *Leptocylindrus danicus*; 28. *Guinardia flaccida*.

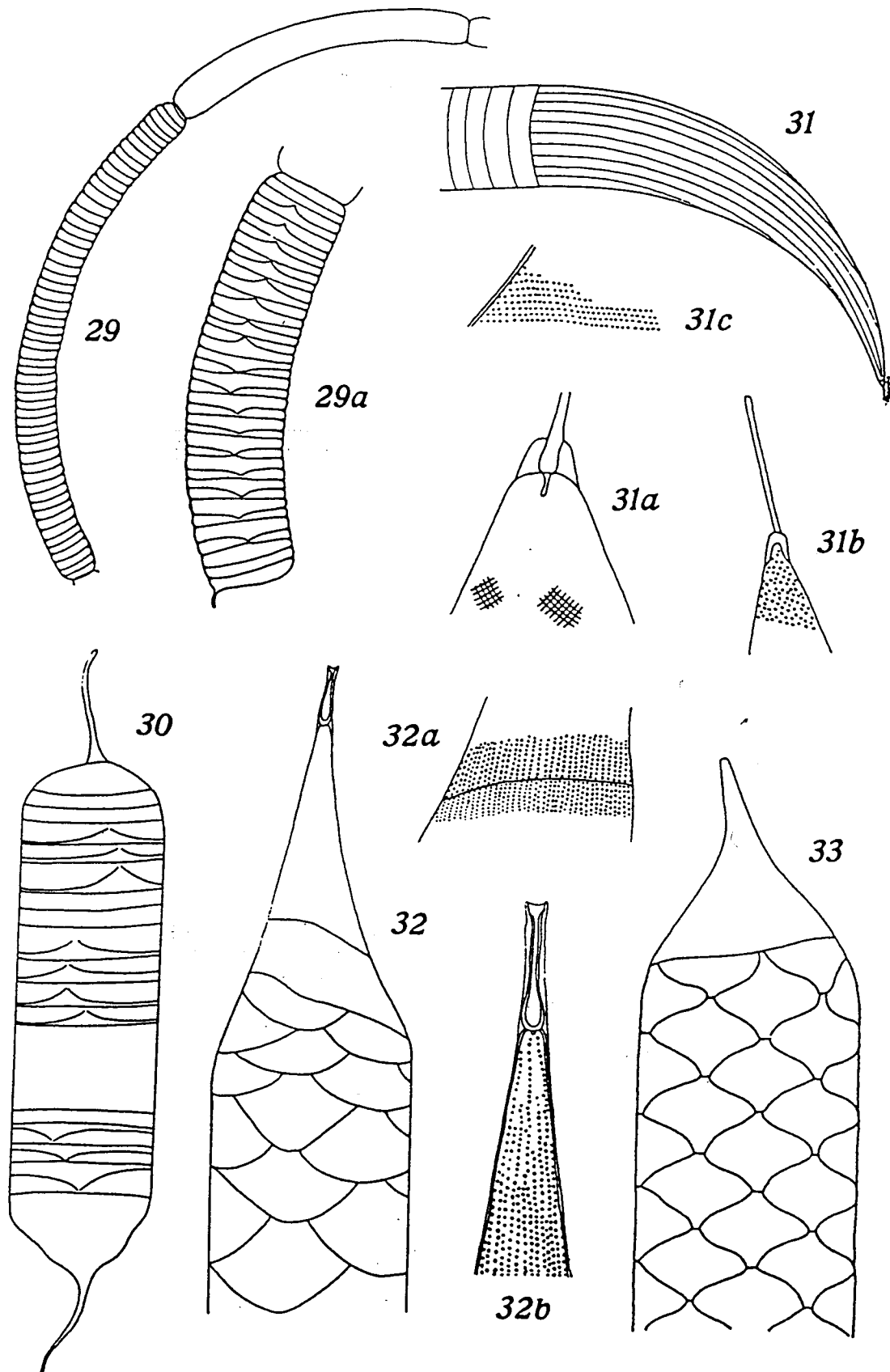

Figs. 29–33. 29. *Rhizosolenia Stolterfothii*; 30. *Rhiz. cylindrus*; 31. *Rhiz. robusta*; 32. *Rhiz. Bergonii*; 33. *Rhiz. arafurensis*.

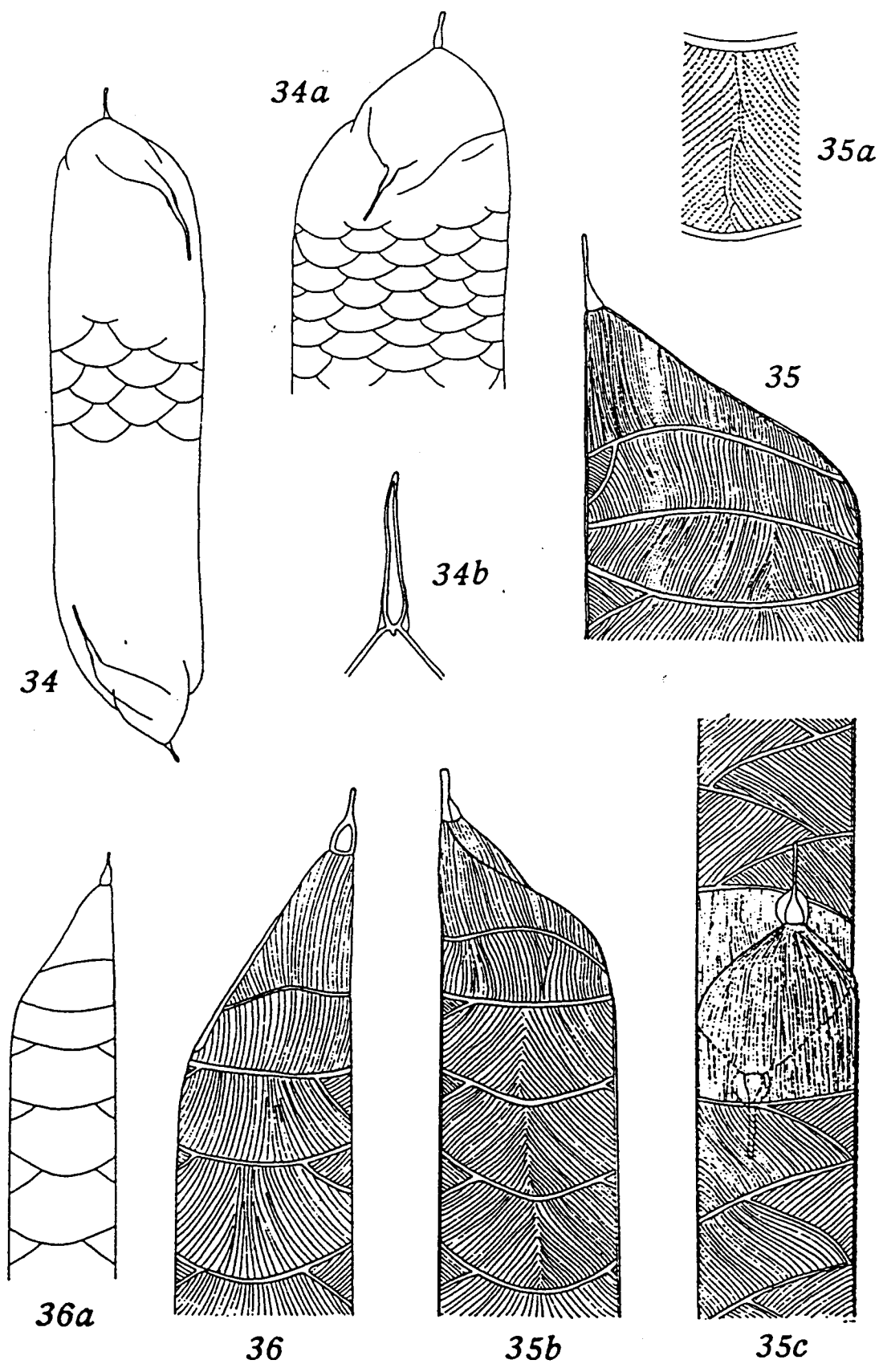

Figs. 34—36. 34. *Rhizosolenia Clevei*; 35. *Rhiz. imbricata*; 36. *Rhiz. imbricata* var. *Shrubsolei*.

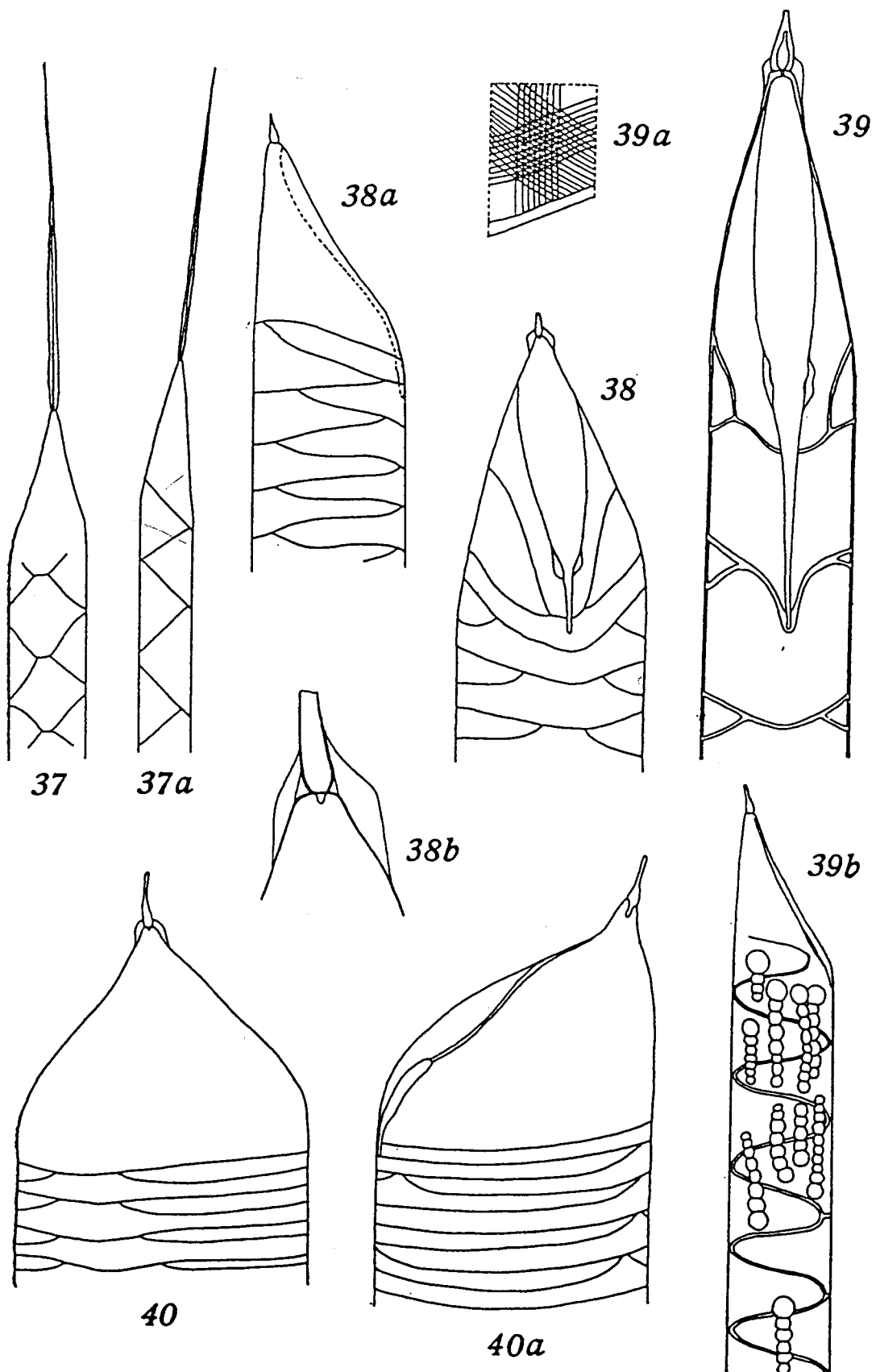

Figs. 37-40. 37. *Rhizosolenia setigera*; 38. *Rhiz. styliformis*; 39. *Rhiz. styliformis* var. *longispina*; 40. *Rhiz. styliformis* var. *latissima*.

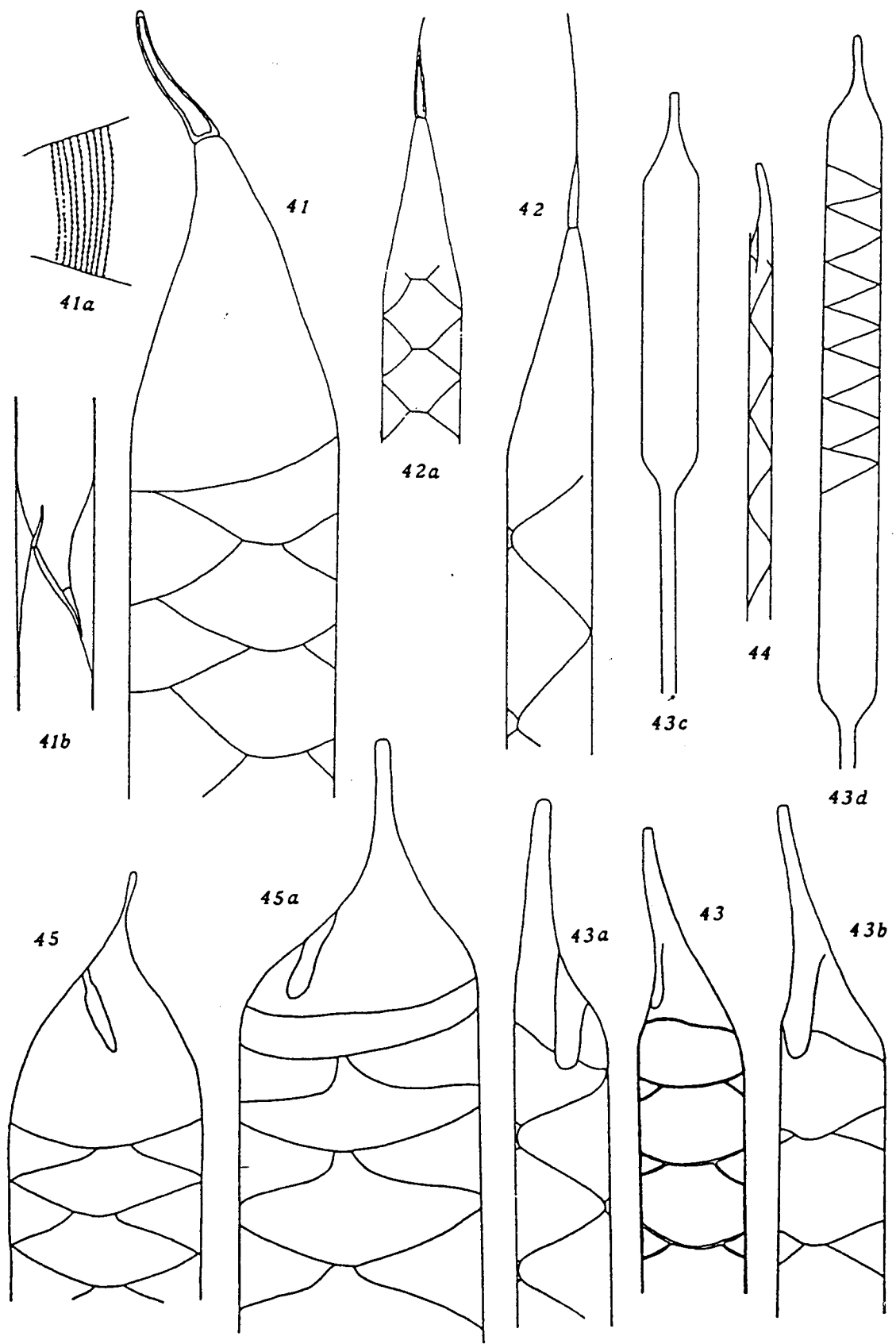

Figs. 41—45. 41. *Rhizosolenia calcar-avis*; 42. *Rhiz. hebetata* form *semispina*;  
 43. *Rhiz. alata* form *genuina*; 44. *Rhiz. alata* form *gracillima*;  
 45. *Rhiz. alata* form *indica*.

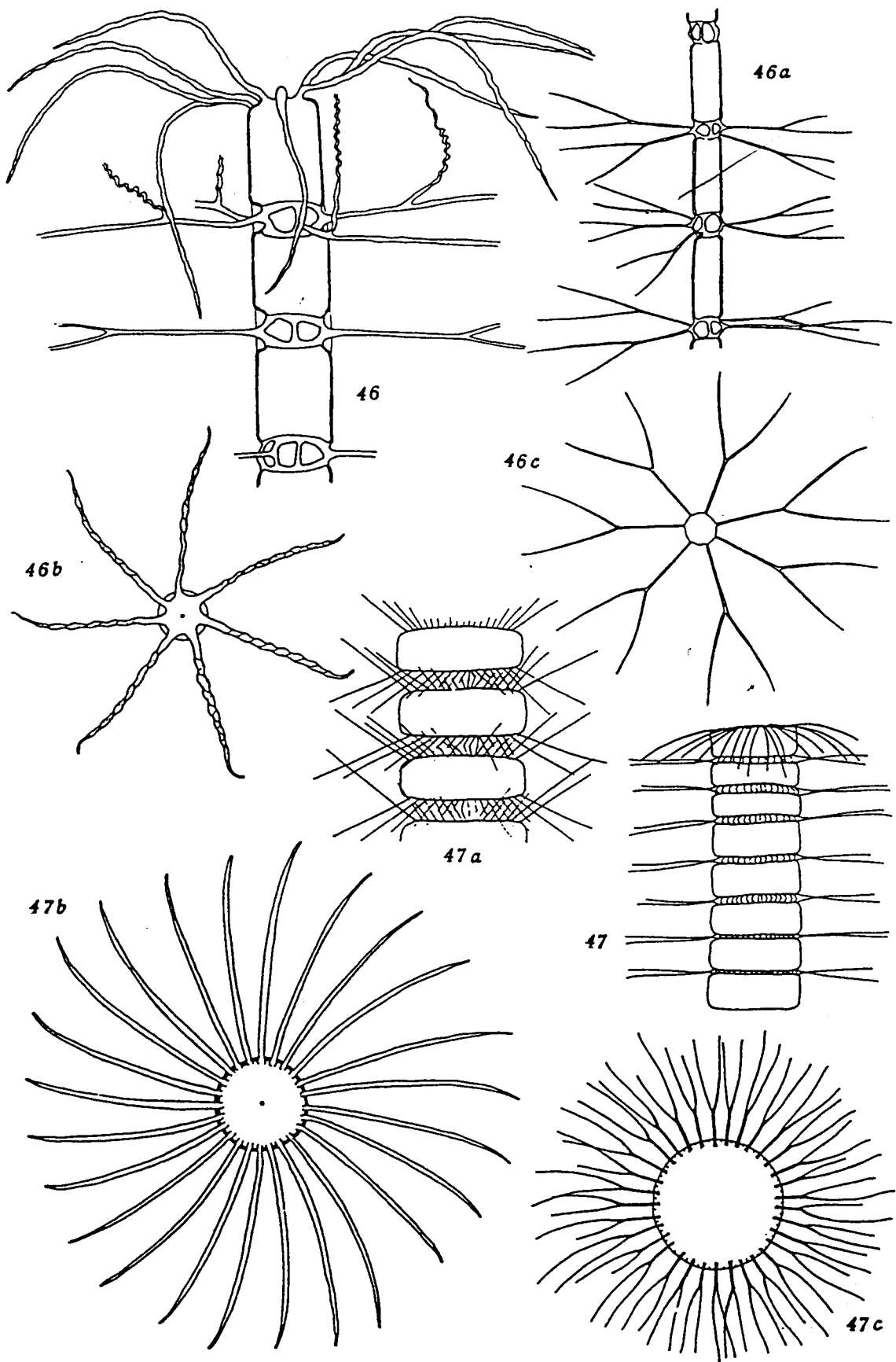

Figs. 46—47. 46. *Bacteriastrum delicatulum*; 47. *Bacter. hyalinum*.

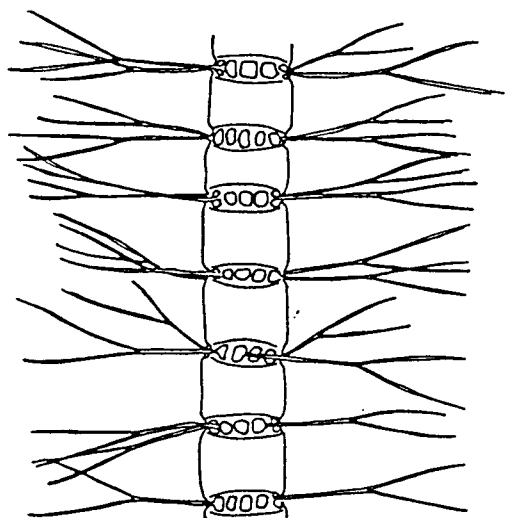

48

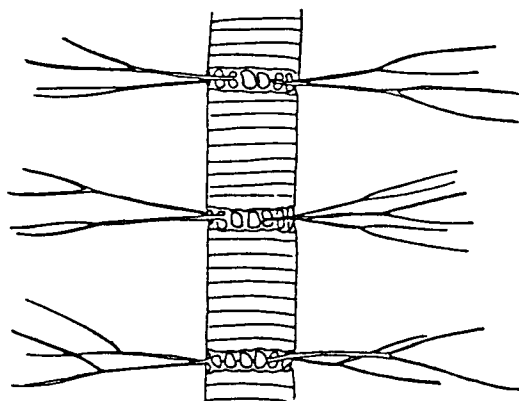

48a

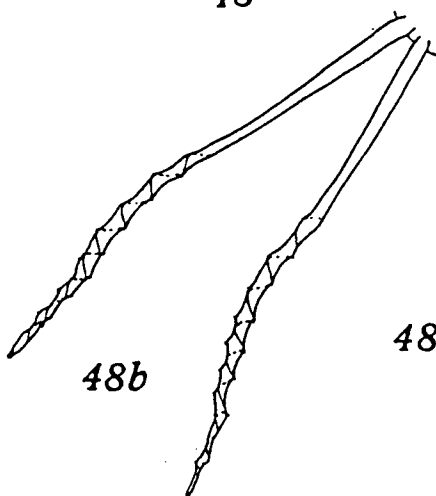

48b

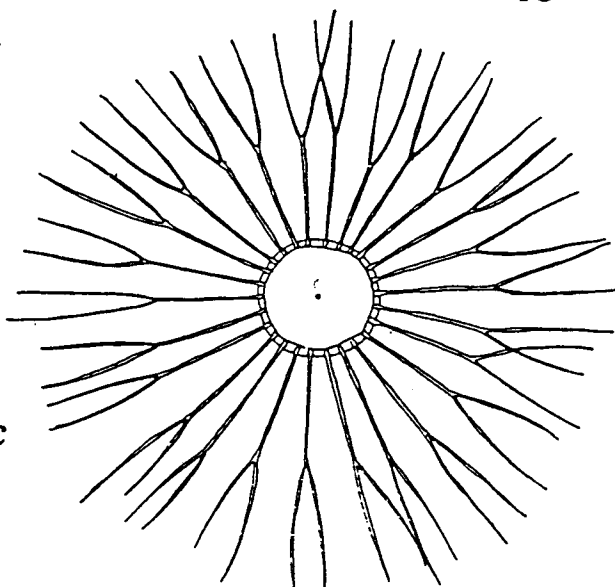

48c

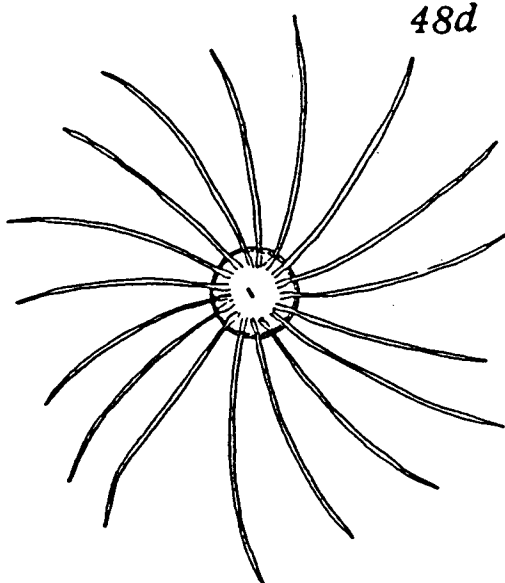

48d

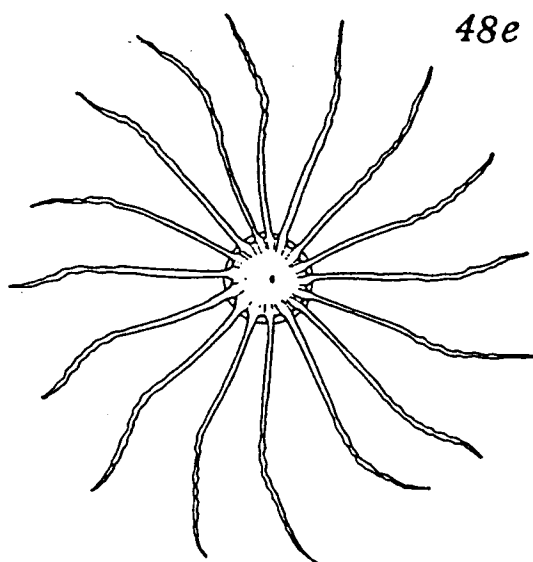

48e

Fig. 48. *Bacteriastrum varians*.

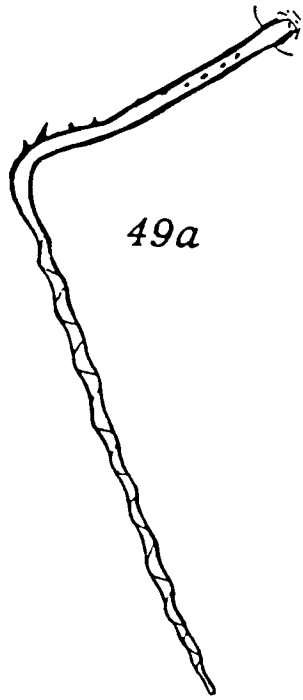

49a

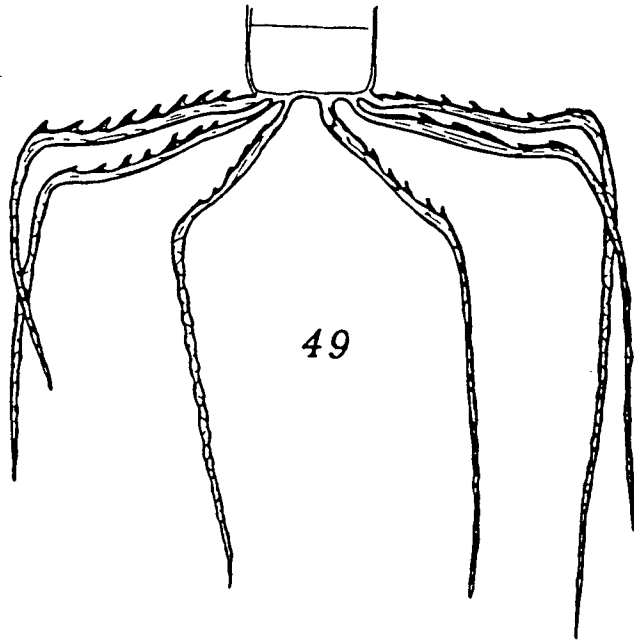

49

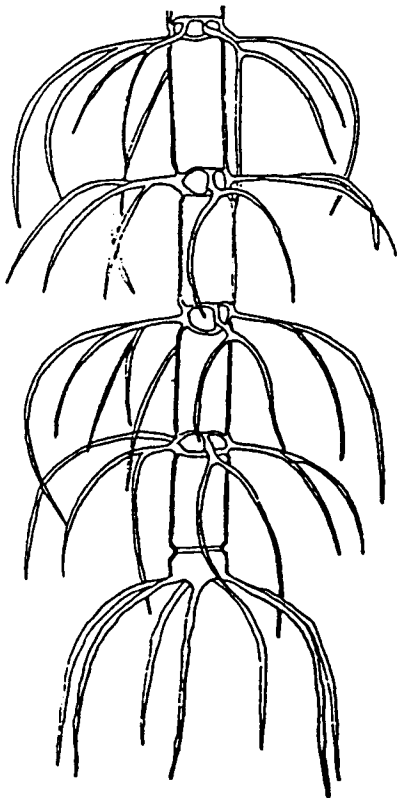

50

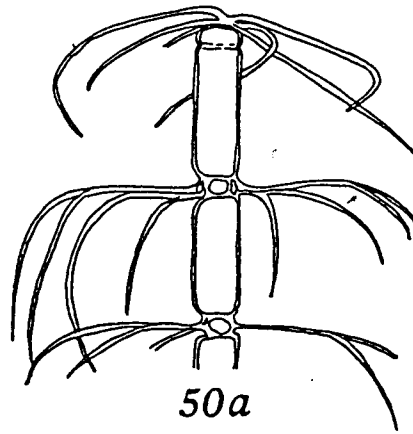

50a

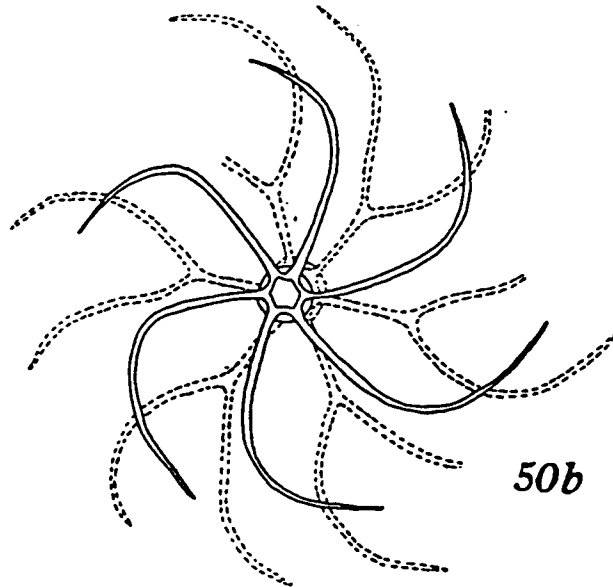

50b

Figs. 49—50. 49. *Bacteriastrum varians* var. *hispida*; 50. *Bacter. comosum*.



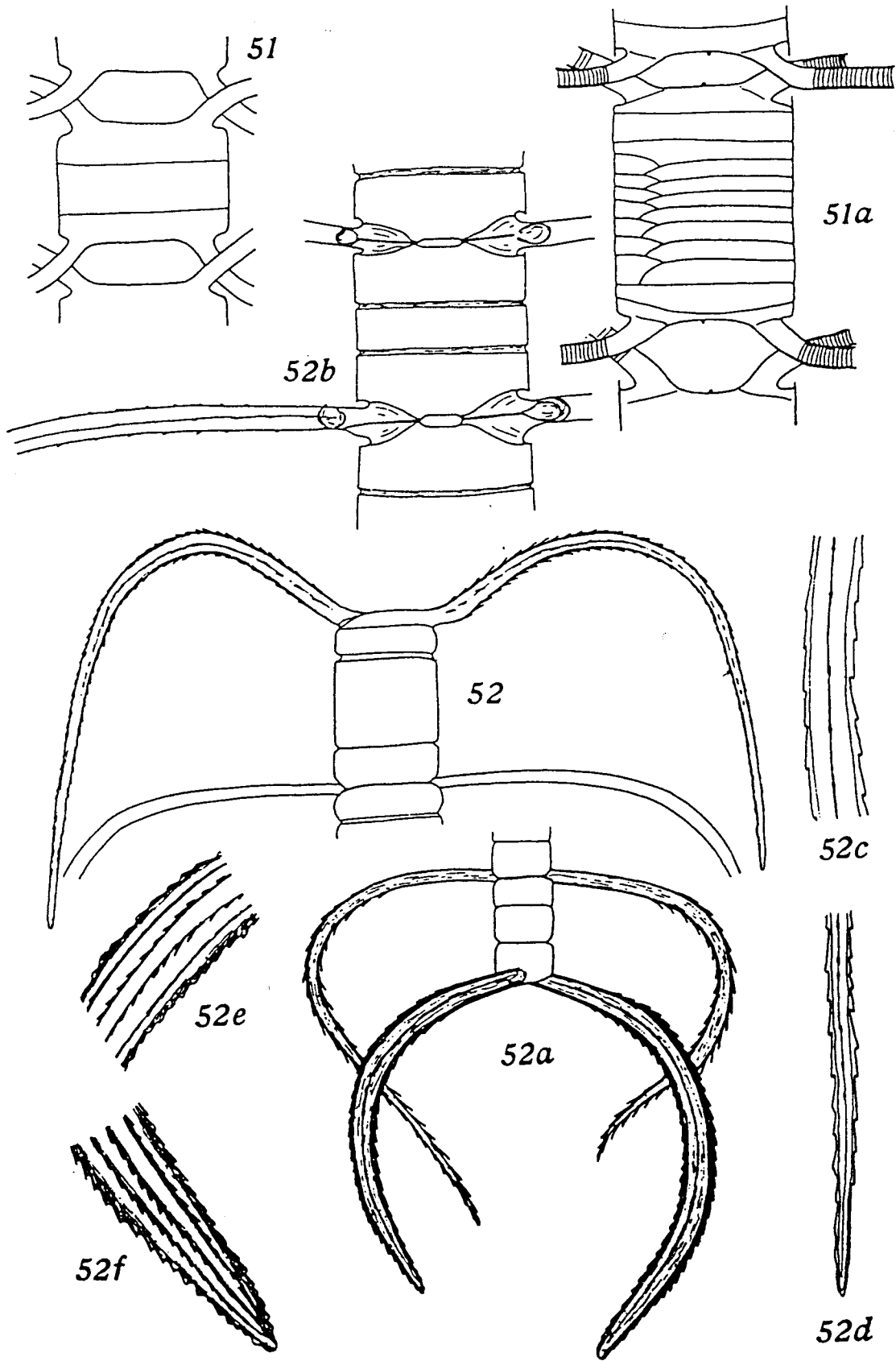

Figs. 51—52. 51. *Chaetoceras Eibenii*; 52. *Ch. coarctatum*.

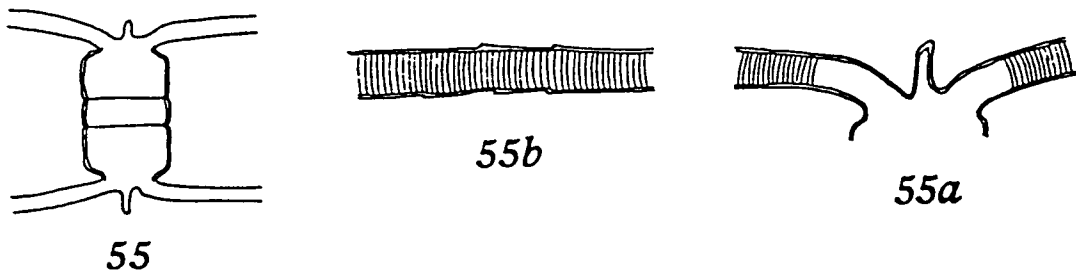
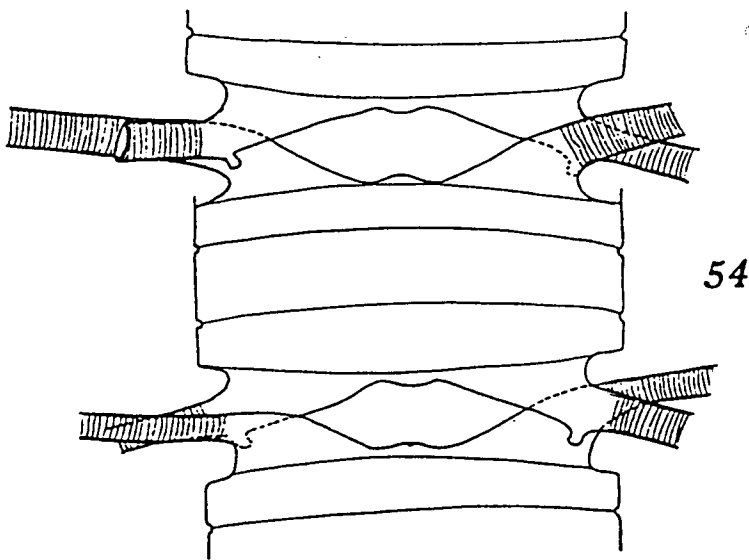
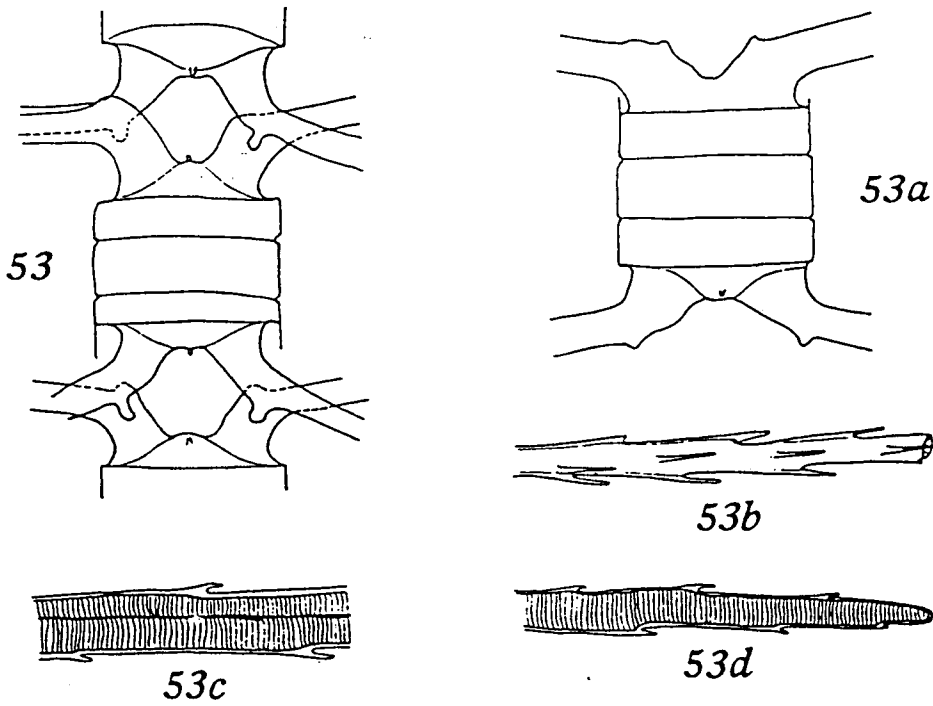

Figs. 53–55. 53. *Chaetoceras denticulatum*; 54. *Ch. nanodenticulatum*; 55. *Ch. rostratum*.

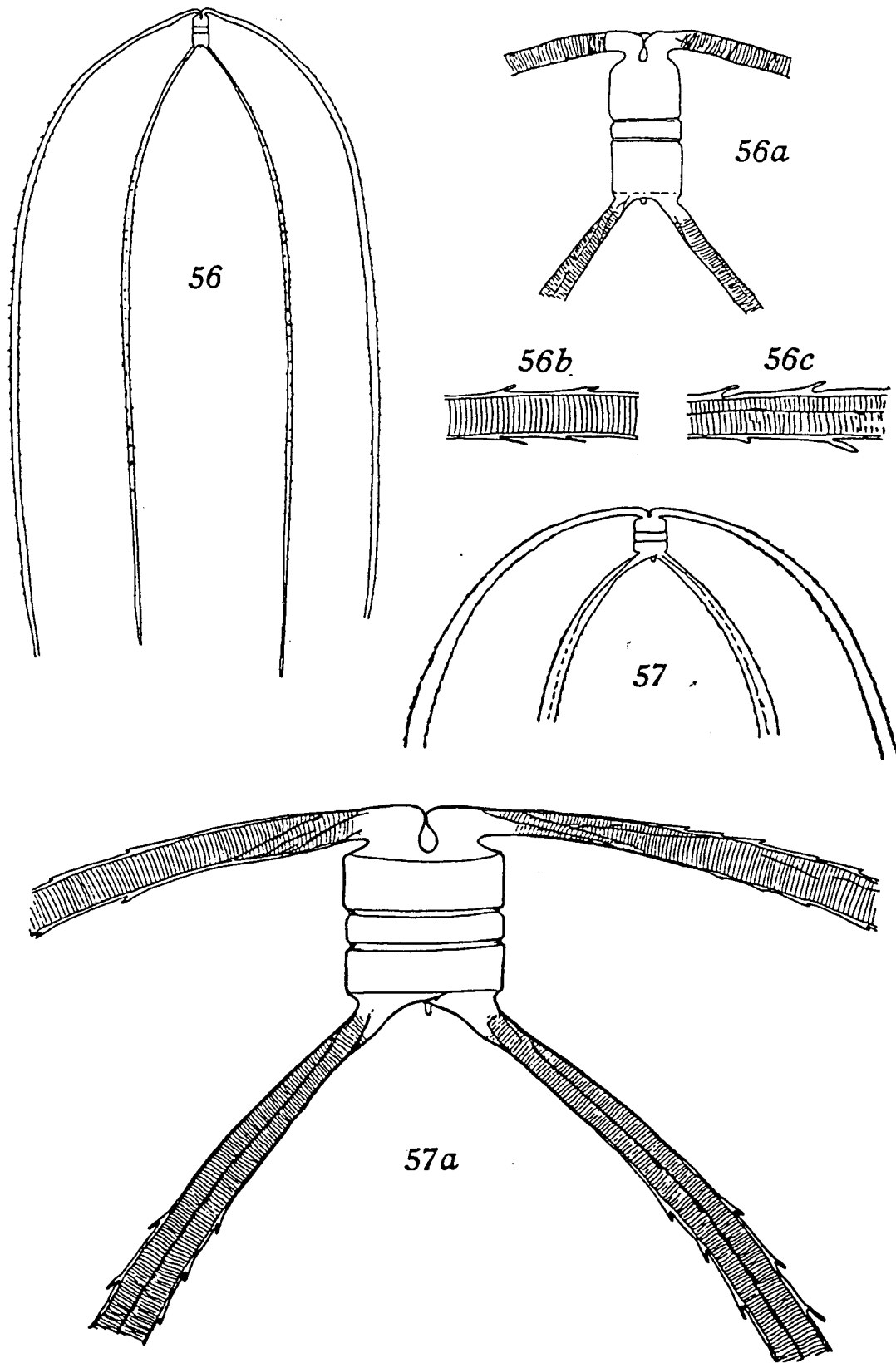

Figs. 56—57. 56. *Chaetoceras peruvianum*; 57. *Ch. peruvianum* form *robusta*.

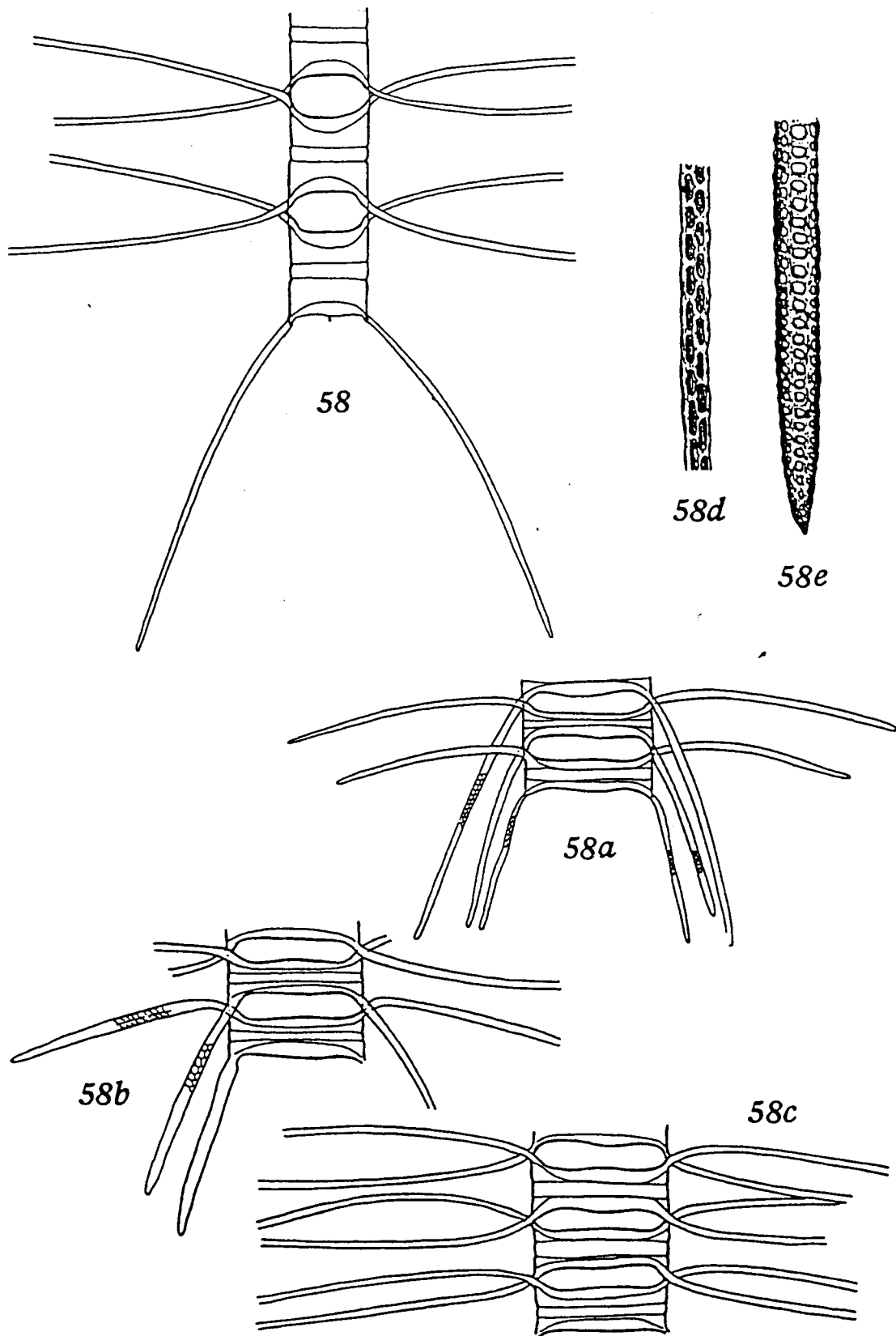
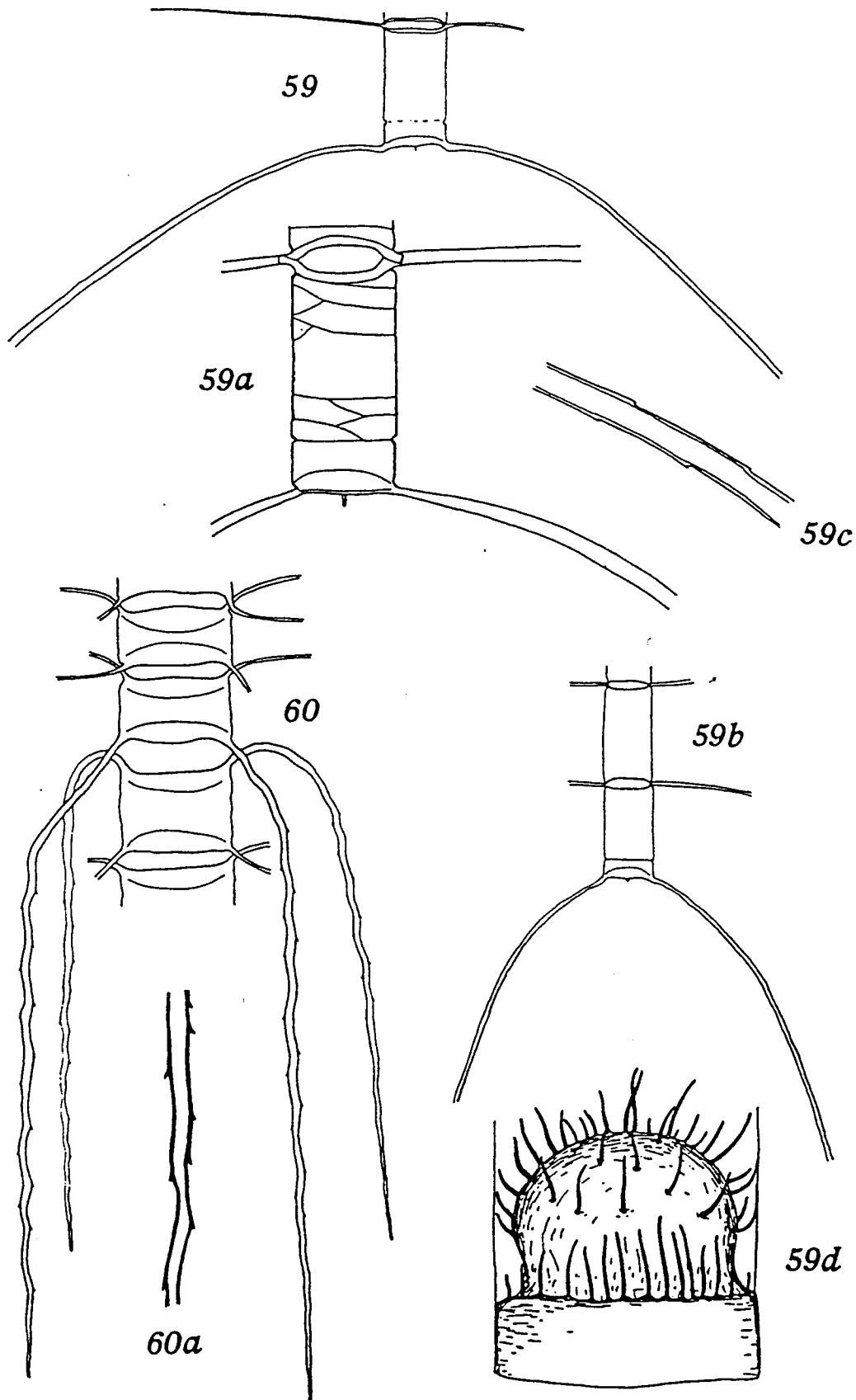
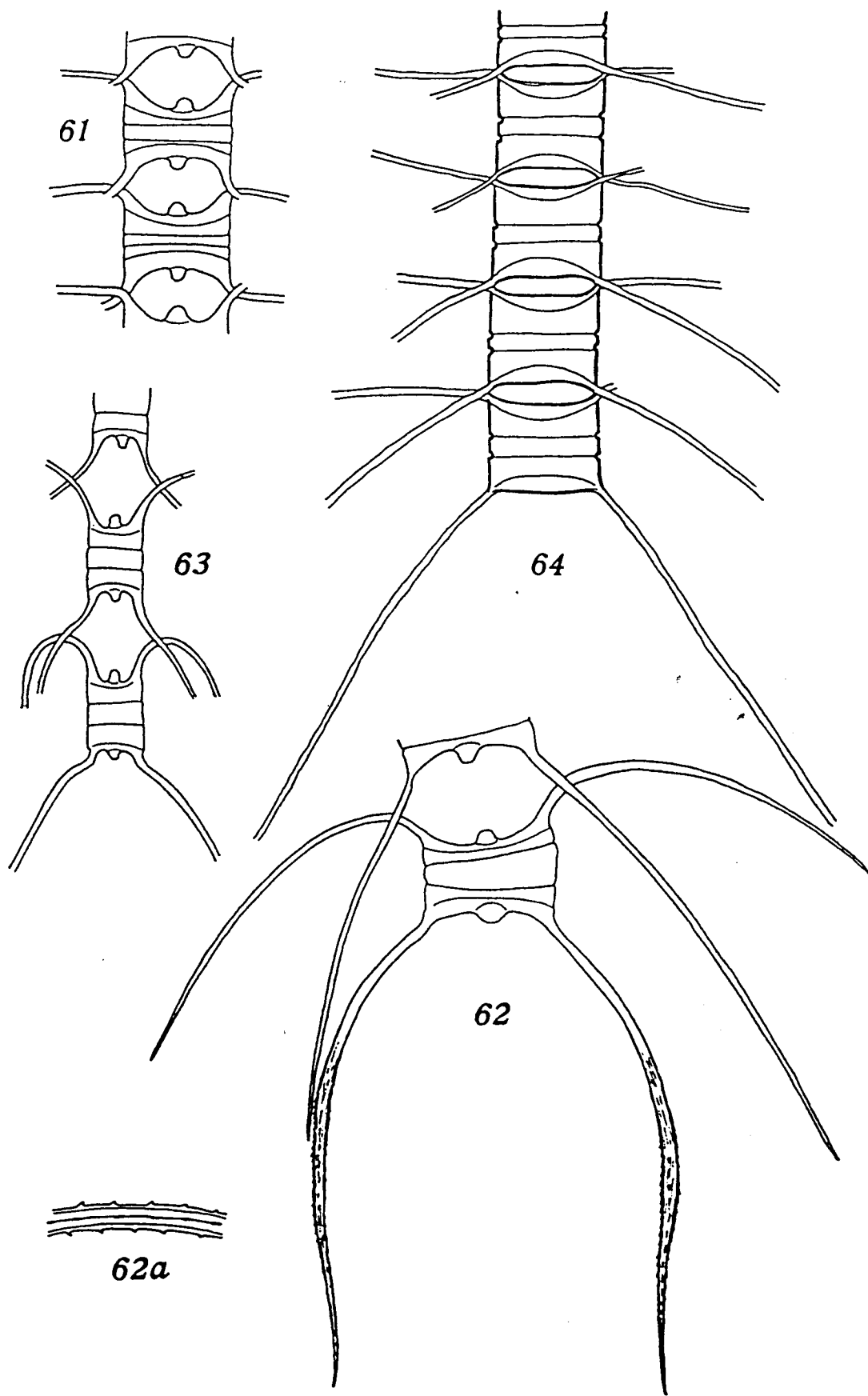

Fig. 58. 58. *Chaetoceras Lorenzianum*.



Figs. 59—60. 59. *Chaetoceras Lauderii*; 60. *Ch. compressum*.



Figs. 61–64. 61. *Chaetoceras didymum*; 62. *Ch. didymum* var. *protuberans*; 63. *Ch. didymum* var. *anglica*; 64. *Ch. constrictum*.

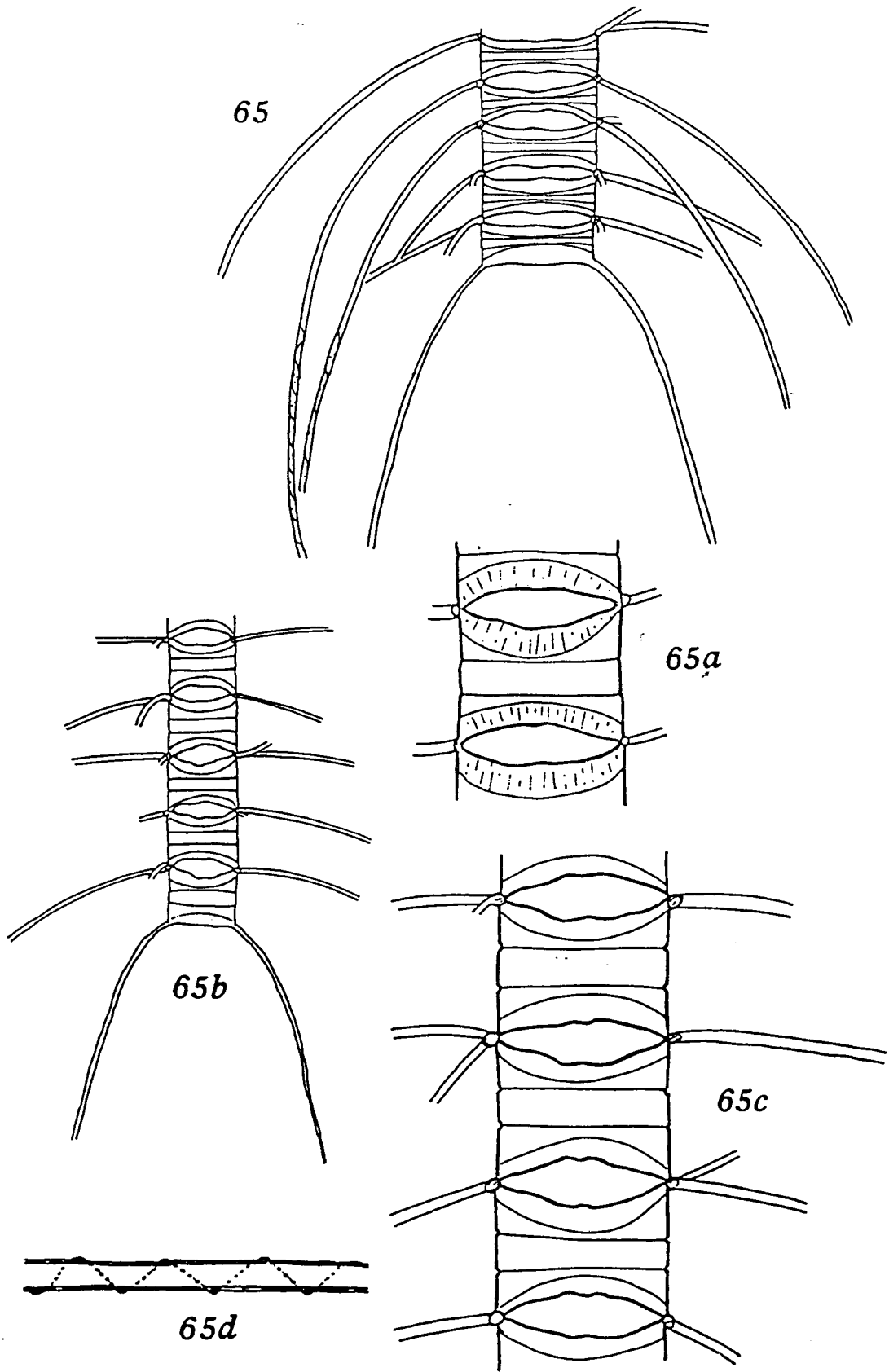

Fig. 65. 65. *Chaetoceras Van Heurckii*.

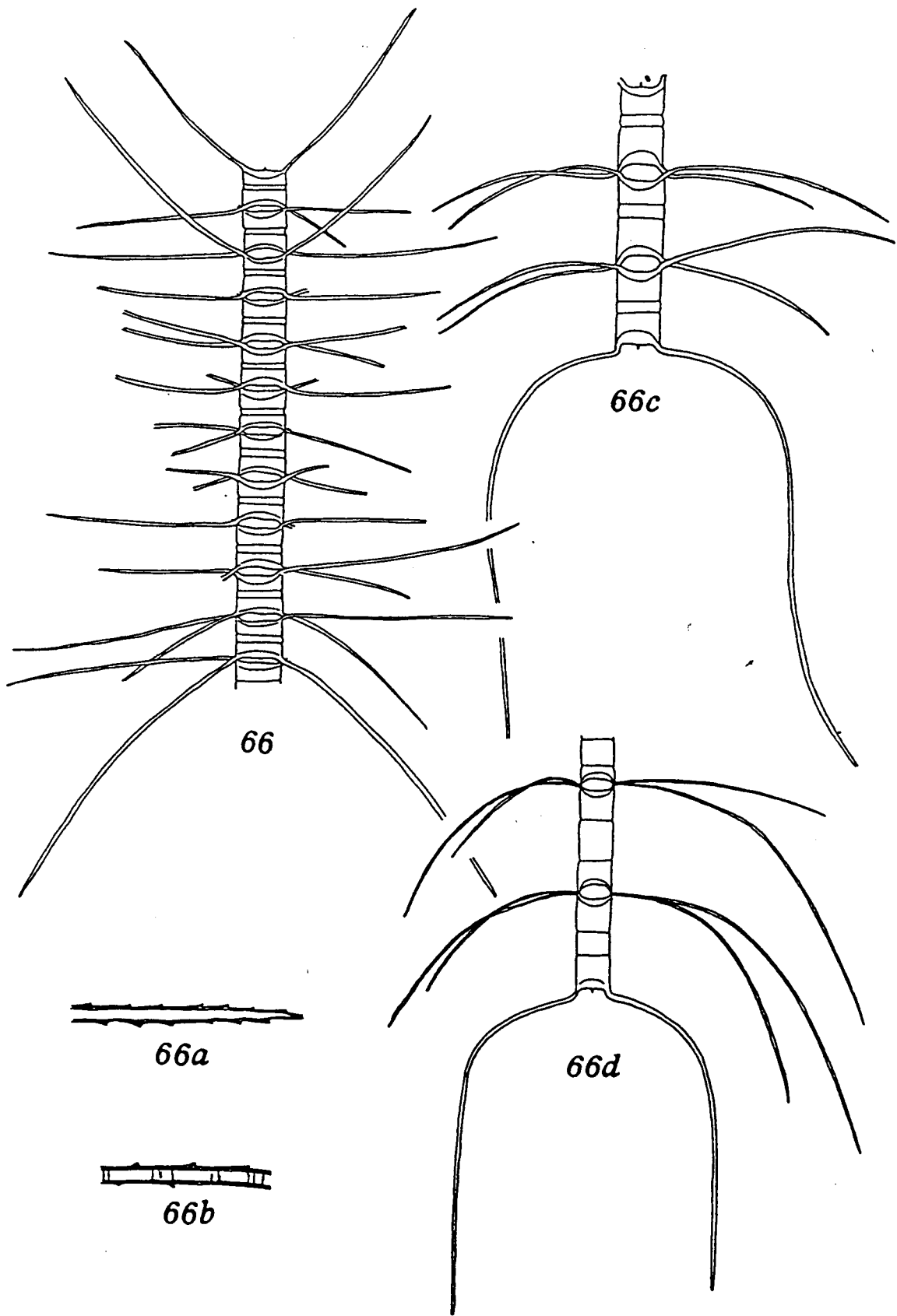
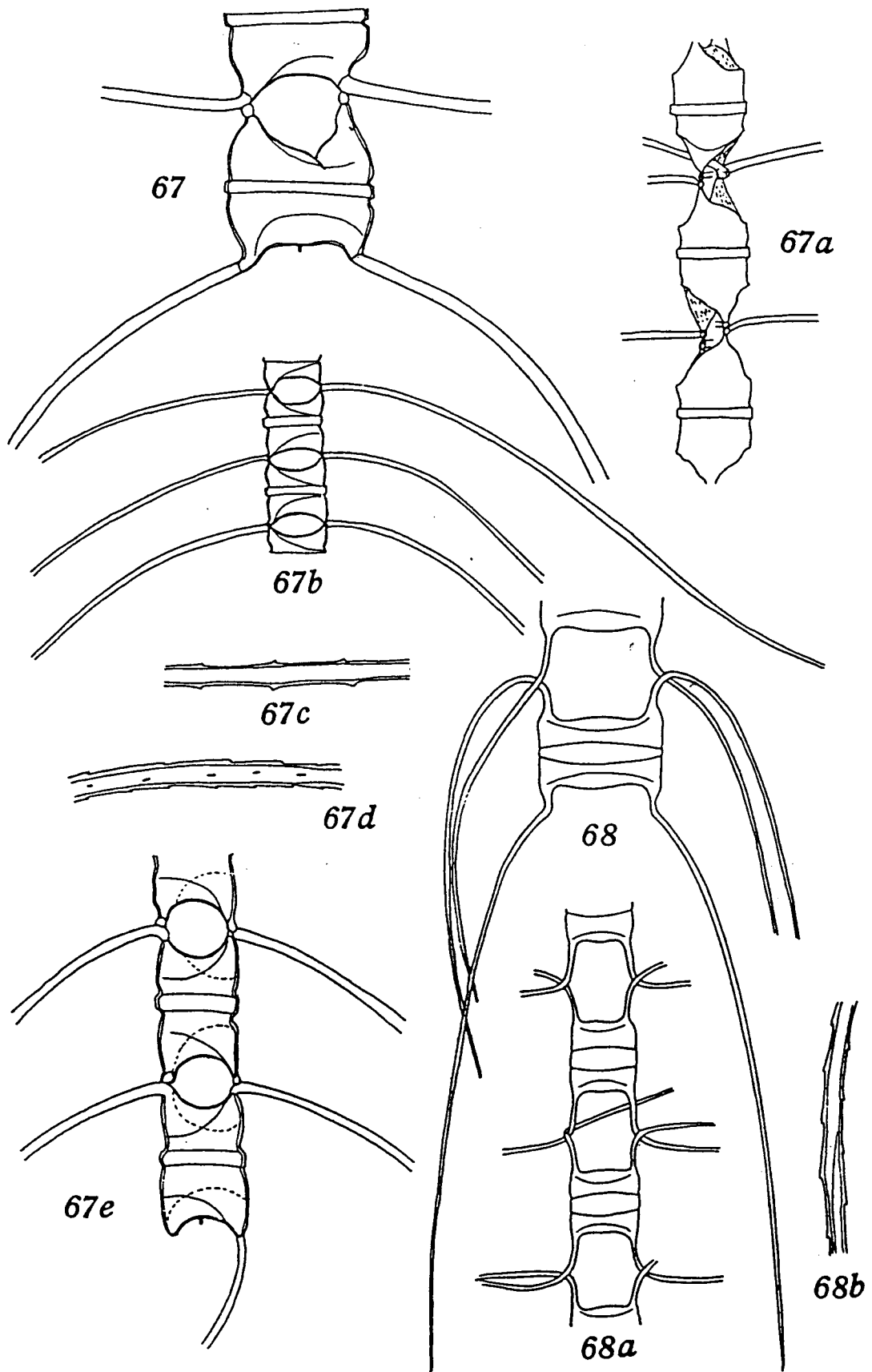
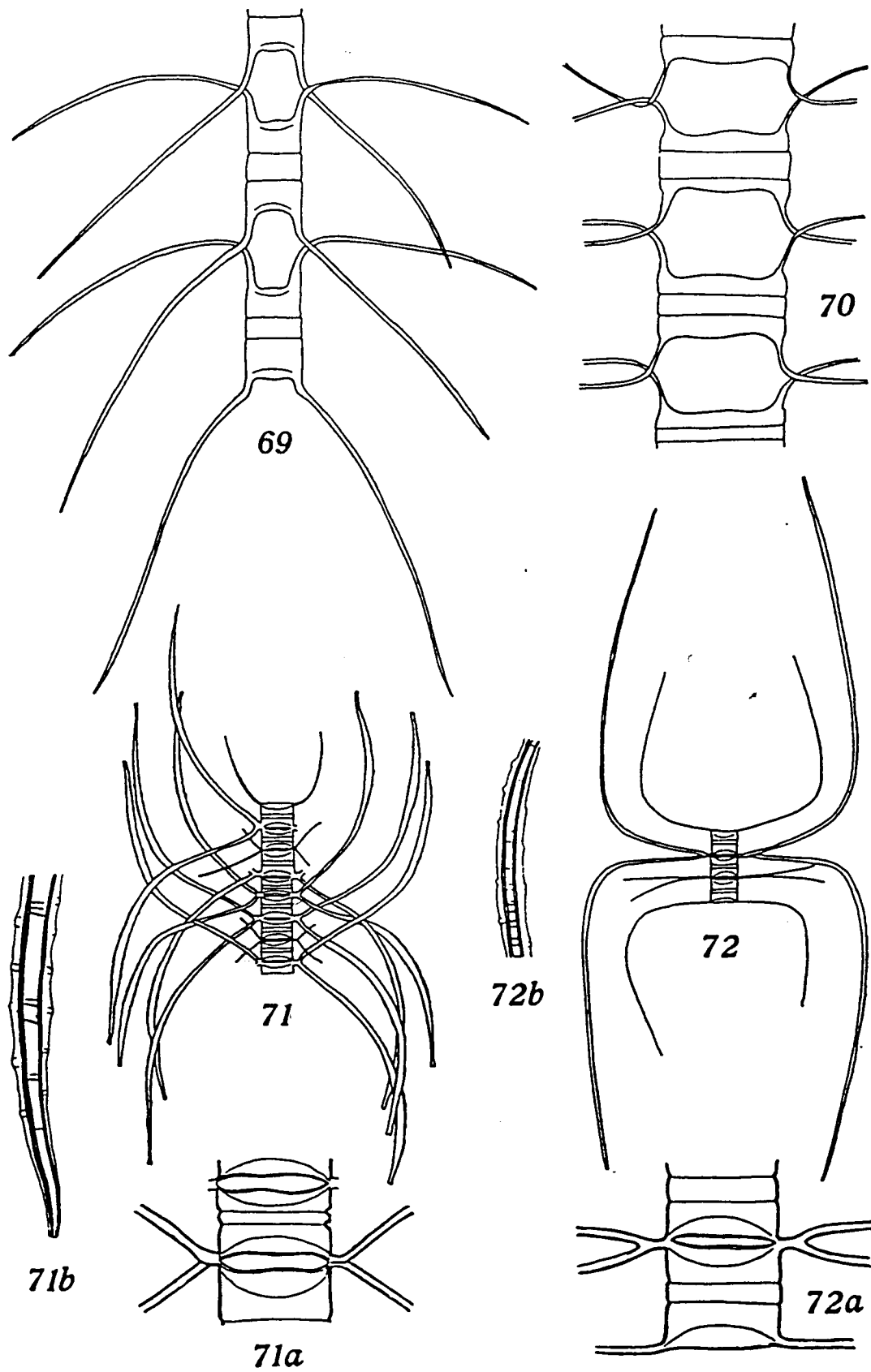

Fig. 66. 66. *Chaetoceras affine*.





Figs. 67—68. 67. *Chaetoceras paradoxum*; 68. *Ch. distans*.



Figs. 69—72. 69. *Chaetoceras lacinosum*; 70. *Ch. breve*; 71. *Ch. diversum*; 72. *Ch. laeve*.

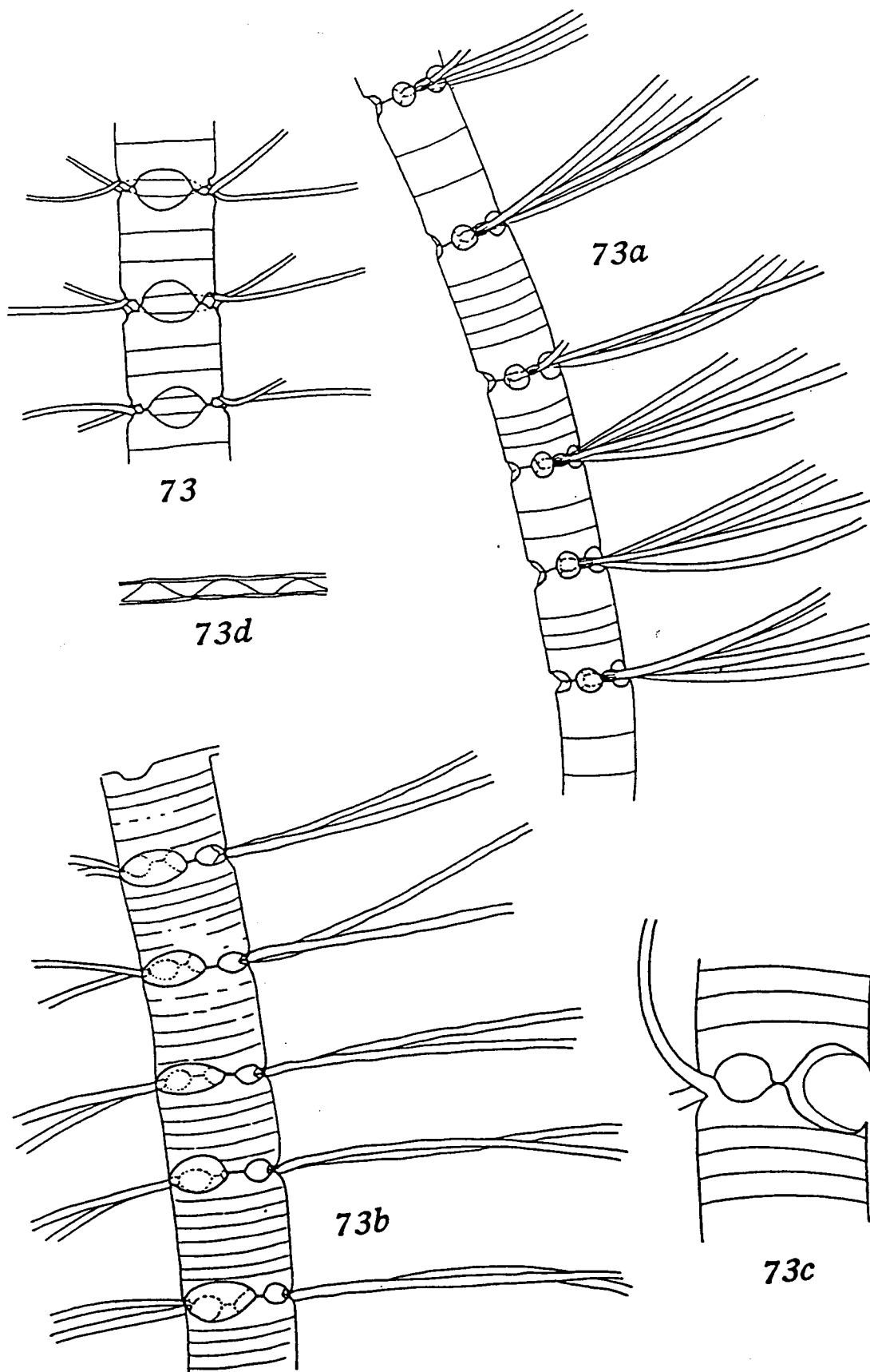
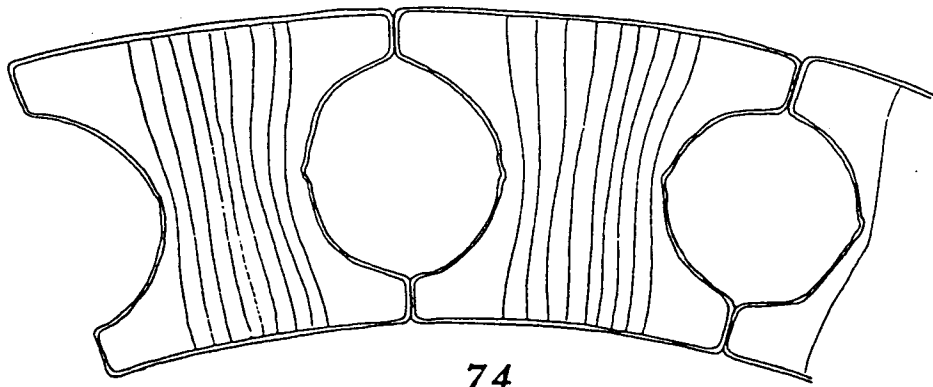
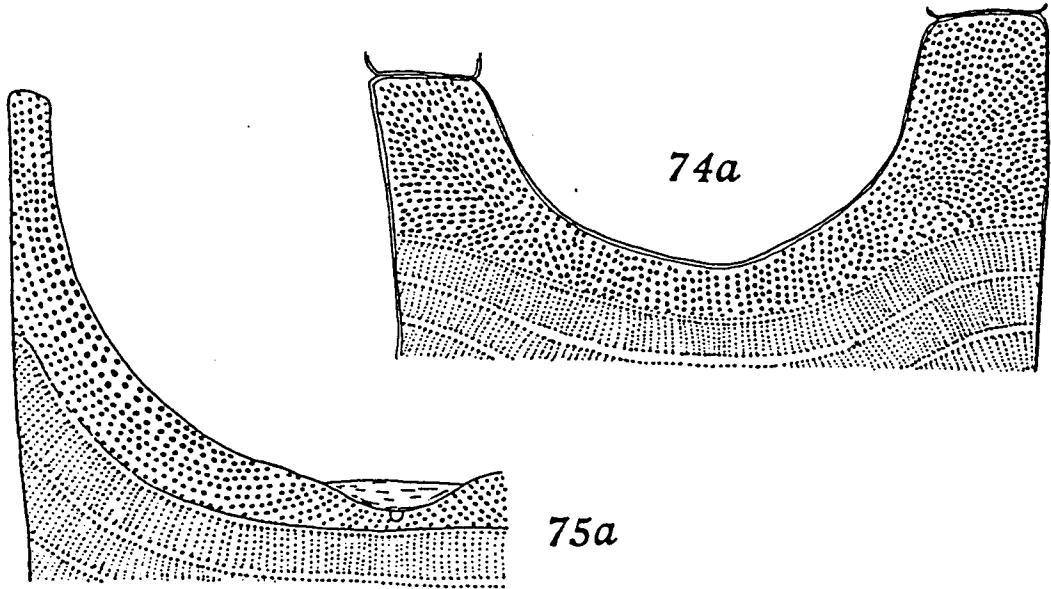

Fig. 73. 73. *Chaetoceras pseudocurvisetum*.



74



74a

75a

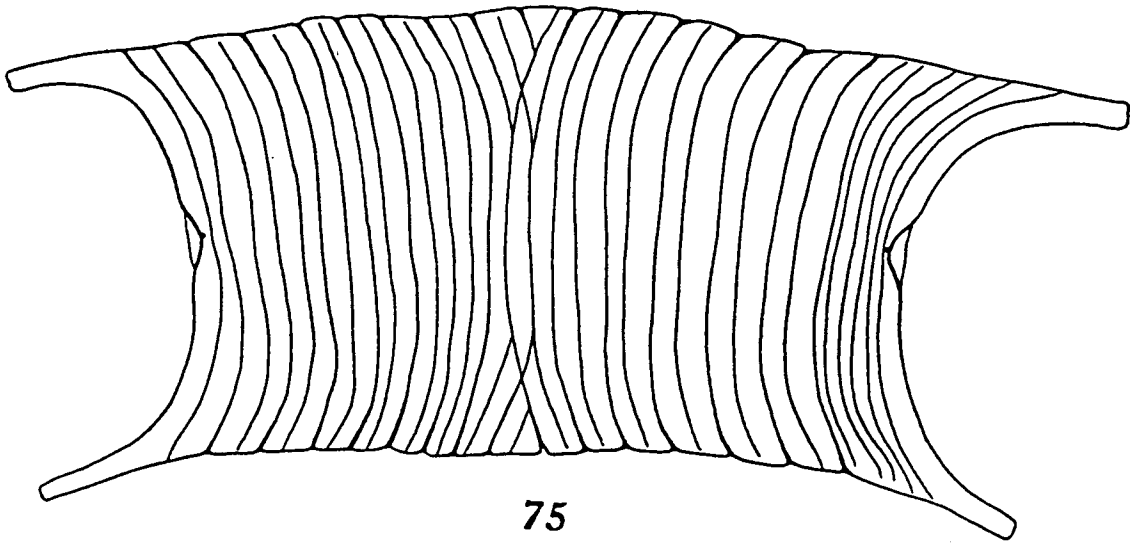

75

Figs. 74—75. 74. *Eucampia zodiacus*; 75. *Eu. cornuta*.

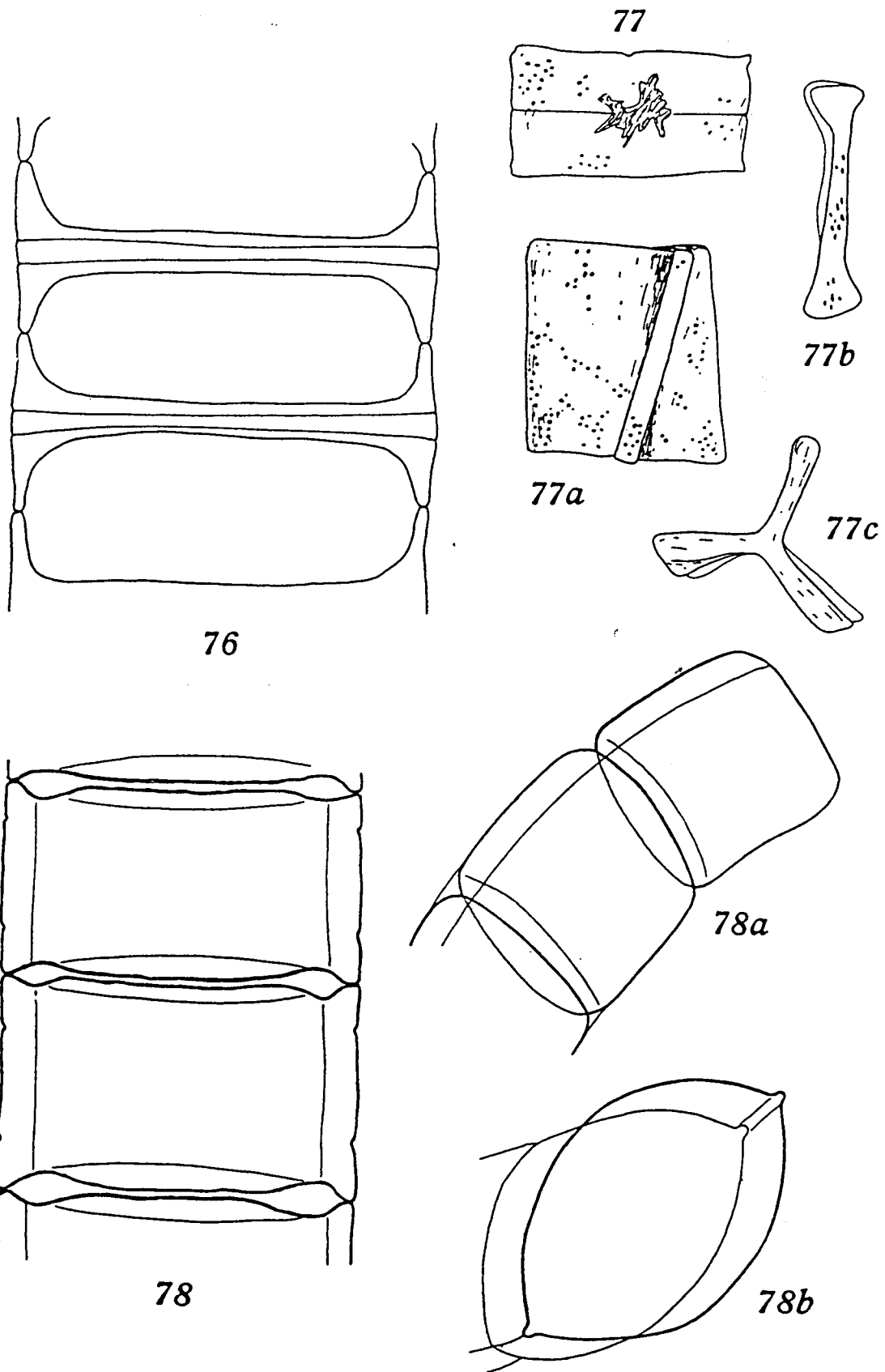

Figs. 76—78. 76. *Climacodium Frauenfeldianum*; 77. *Streptothecha indica*; 78. *Bellerochea malleus* form *biangulata*.

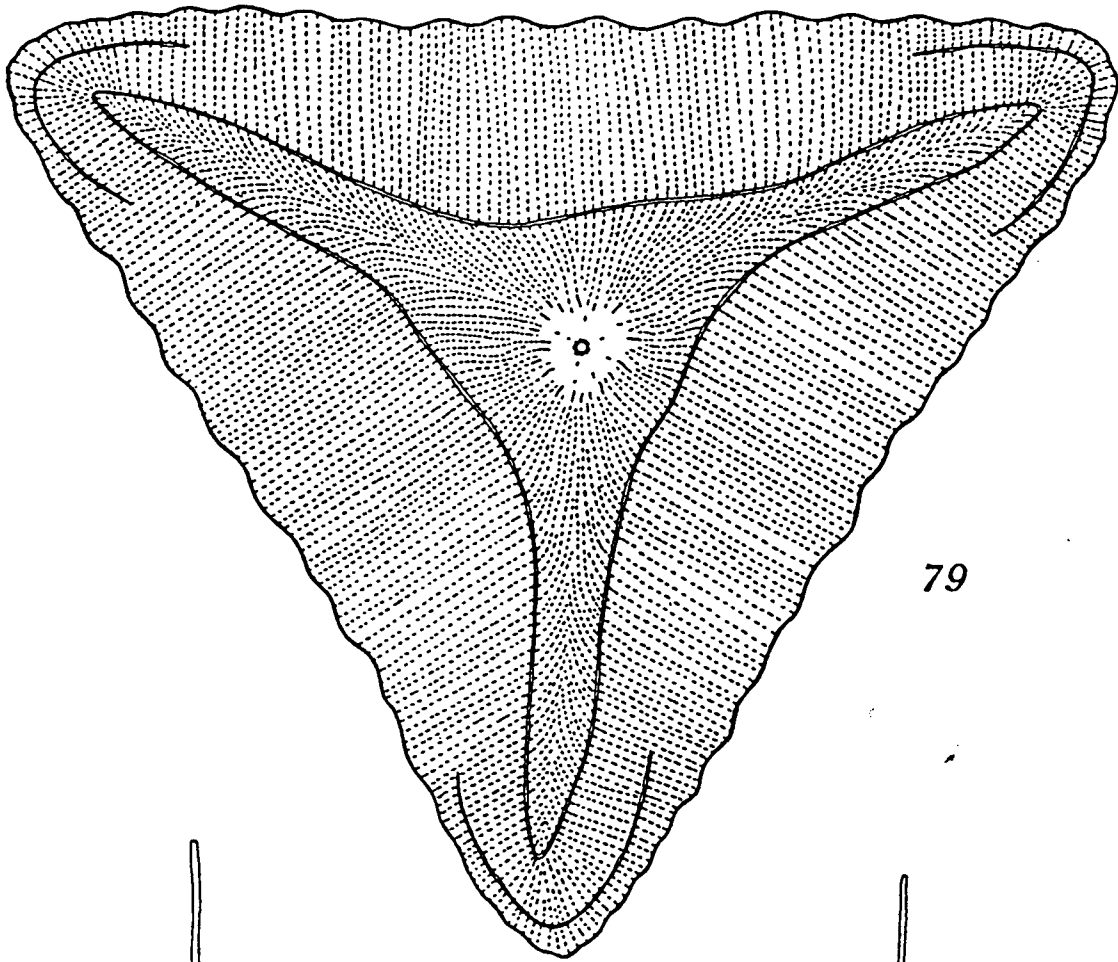

79

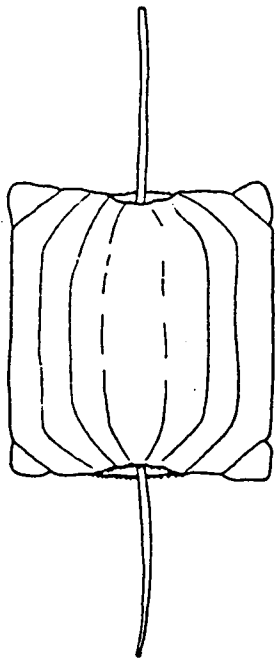

79a

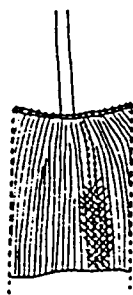

79c



79b

Fig. 79. *Ditylum sol.*

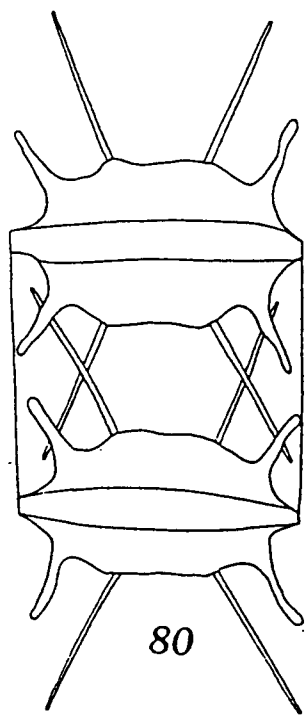

80

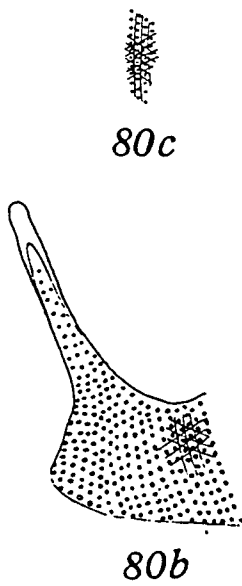

80b

80c

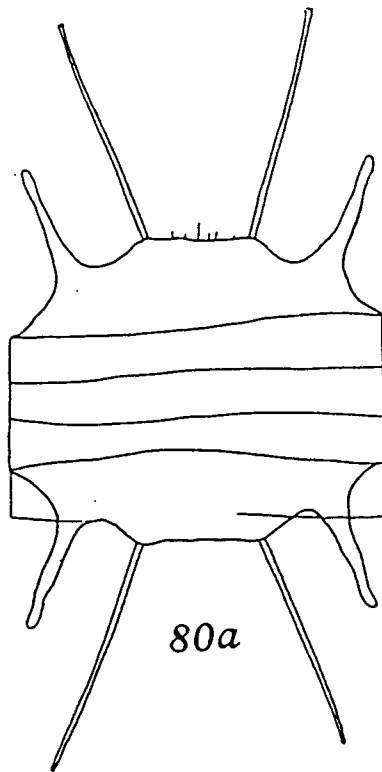

80a

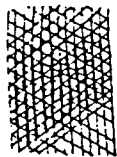

81b

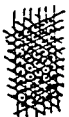

81c

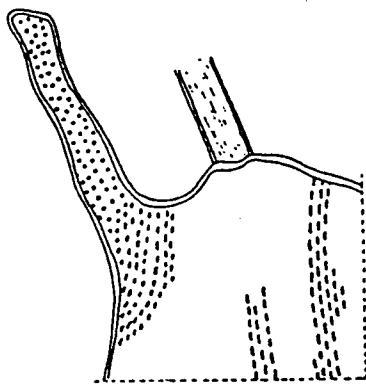

81d

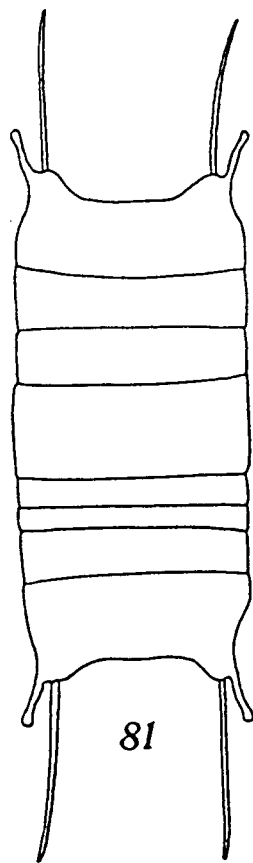

81

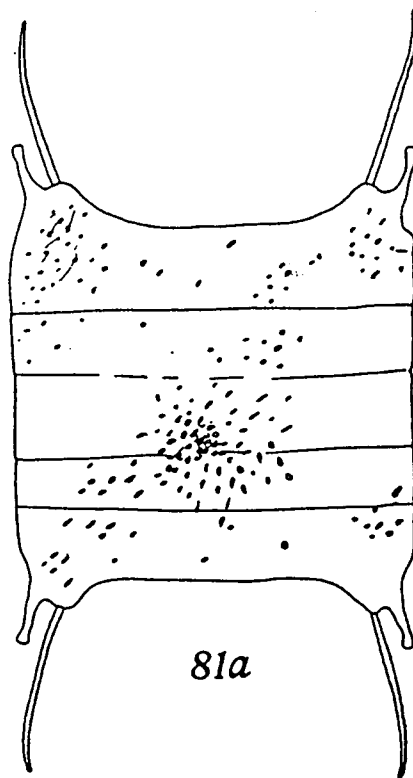

81a

Figs. 80—81. 80. *Biddulphia mobiliensis*; 81. *Bid. sinensis*.

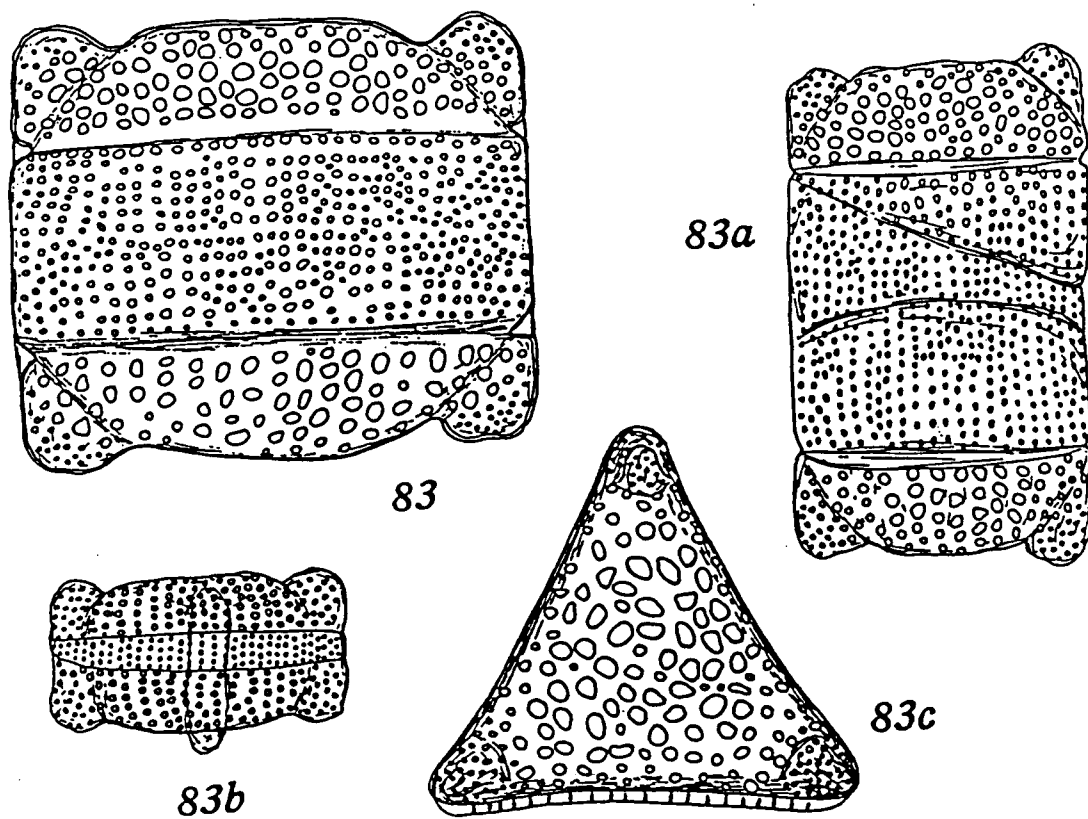
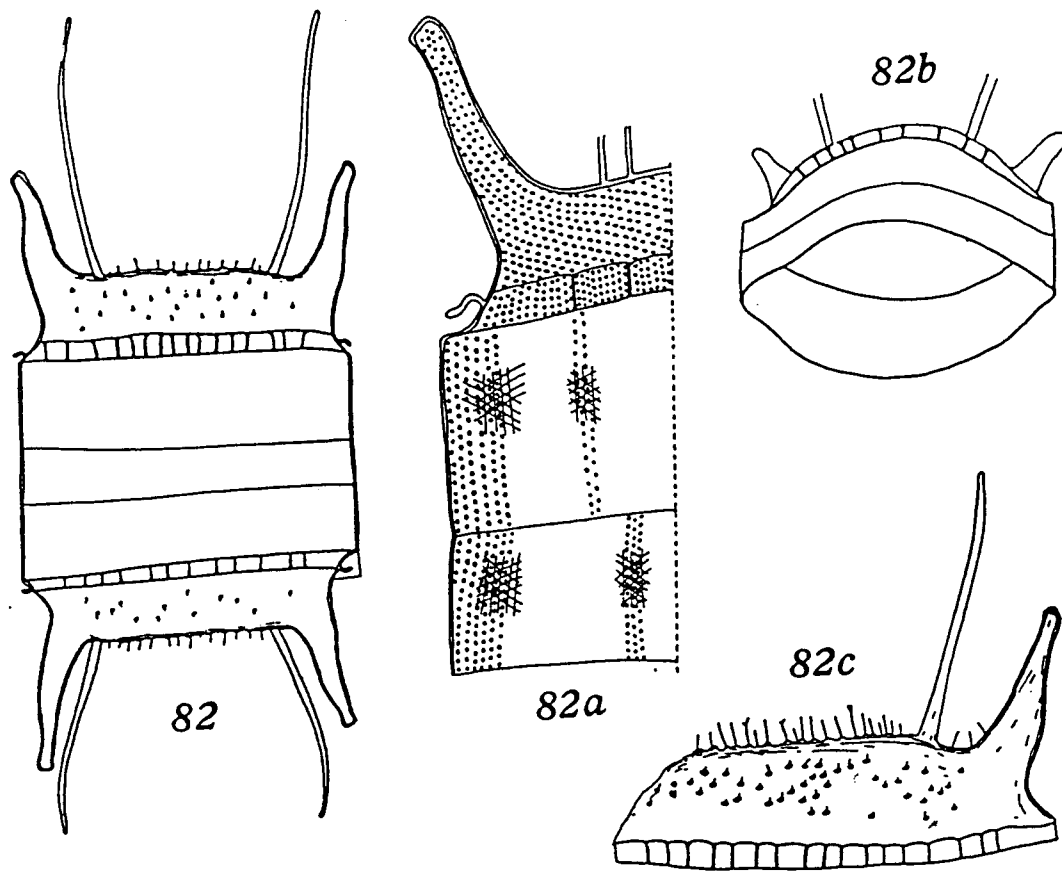

Figs. 82—83. 82. *Biddulphia heteroceros*; 83. *Bid. reticulum*.



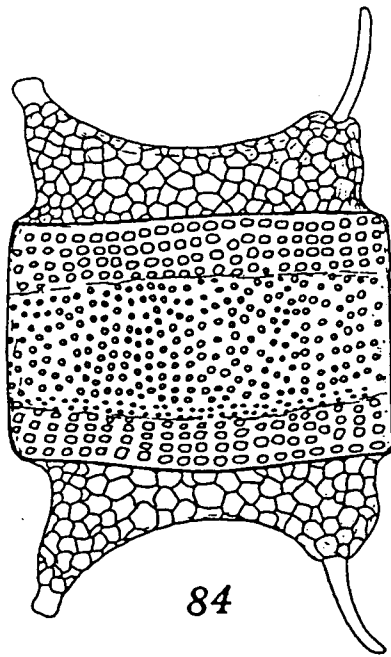

84

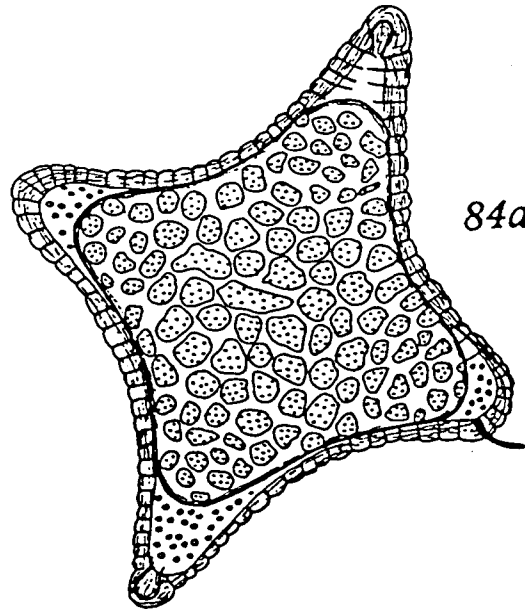

84a

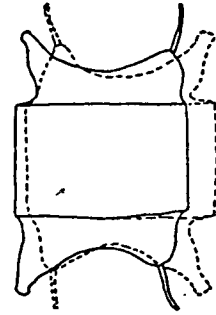

84b

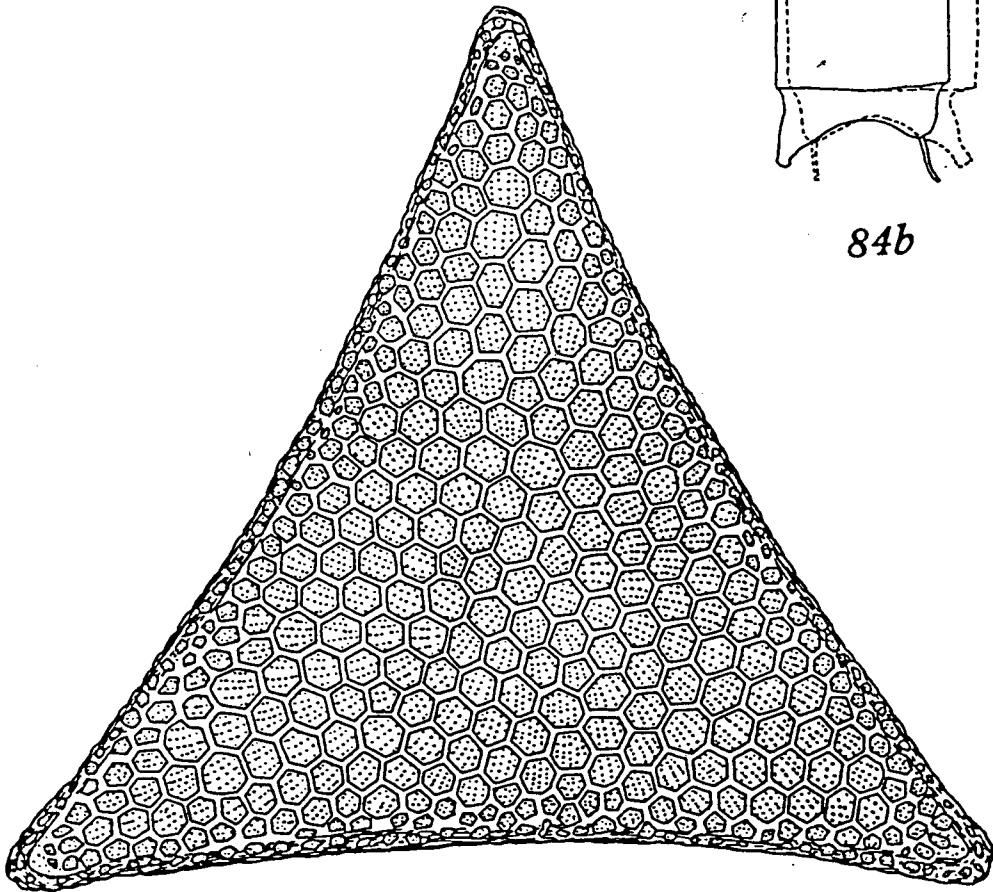

85

Figs. 84–85. 84. *Biddulphia dubia*; 85. *Bid.* species.

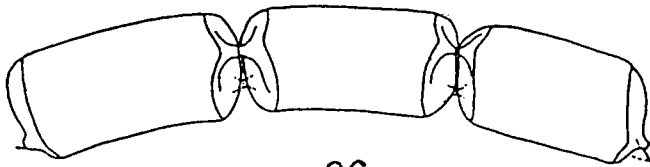

86

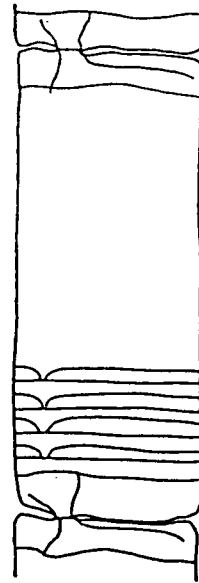

87

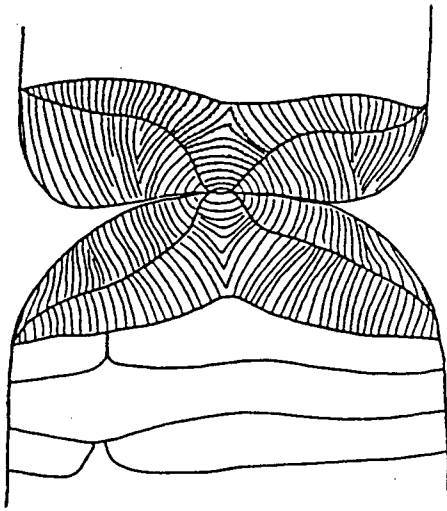

86a

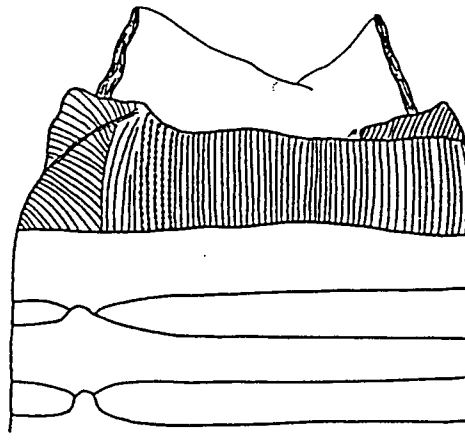

87a

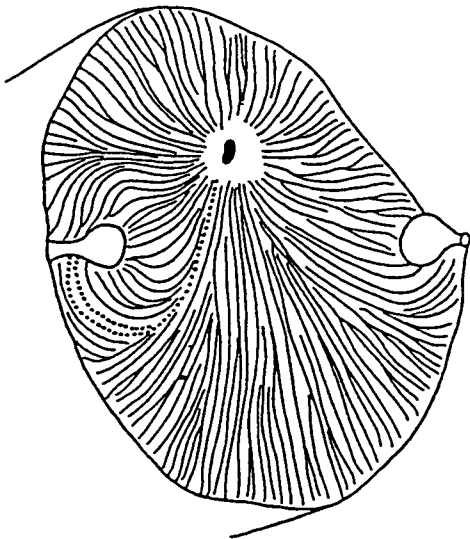

86b

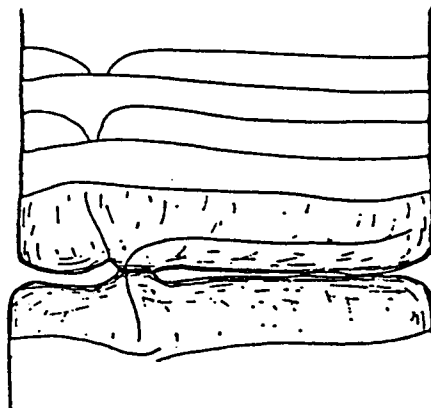

87b

Figs. 86–87. 86. *Cerataulina Bergonii*; 87. *Cer. compacta*.

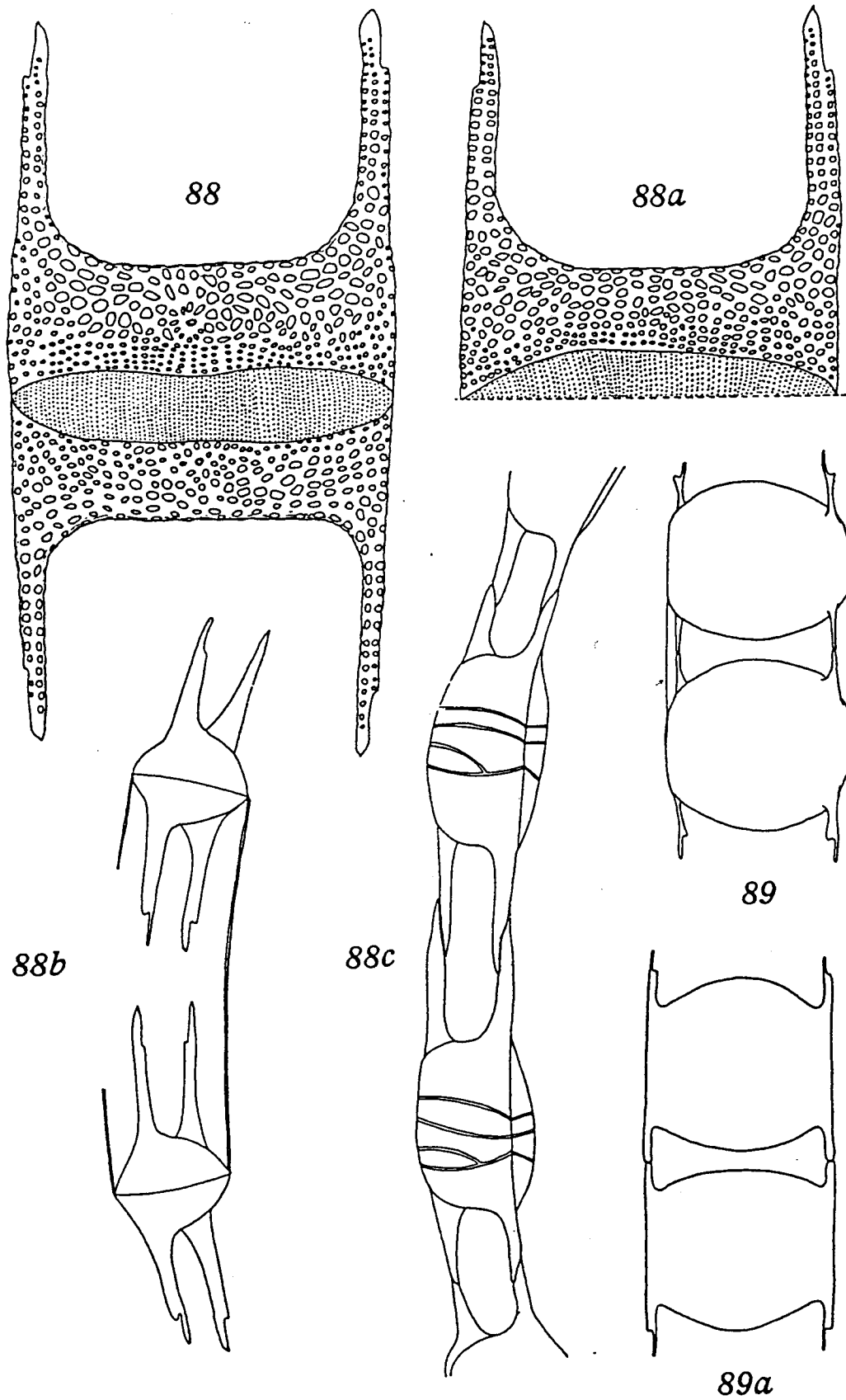

Figs. 88—89. 88. *Hemiaulus sinensis*; 89. *Hem. indicus*.

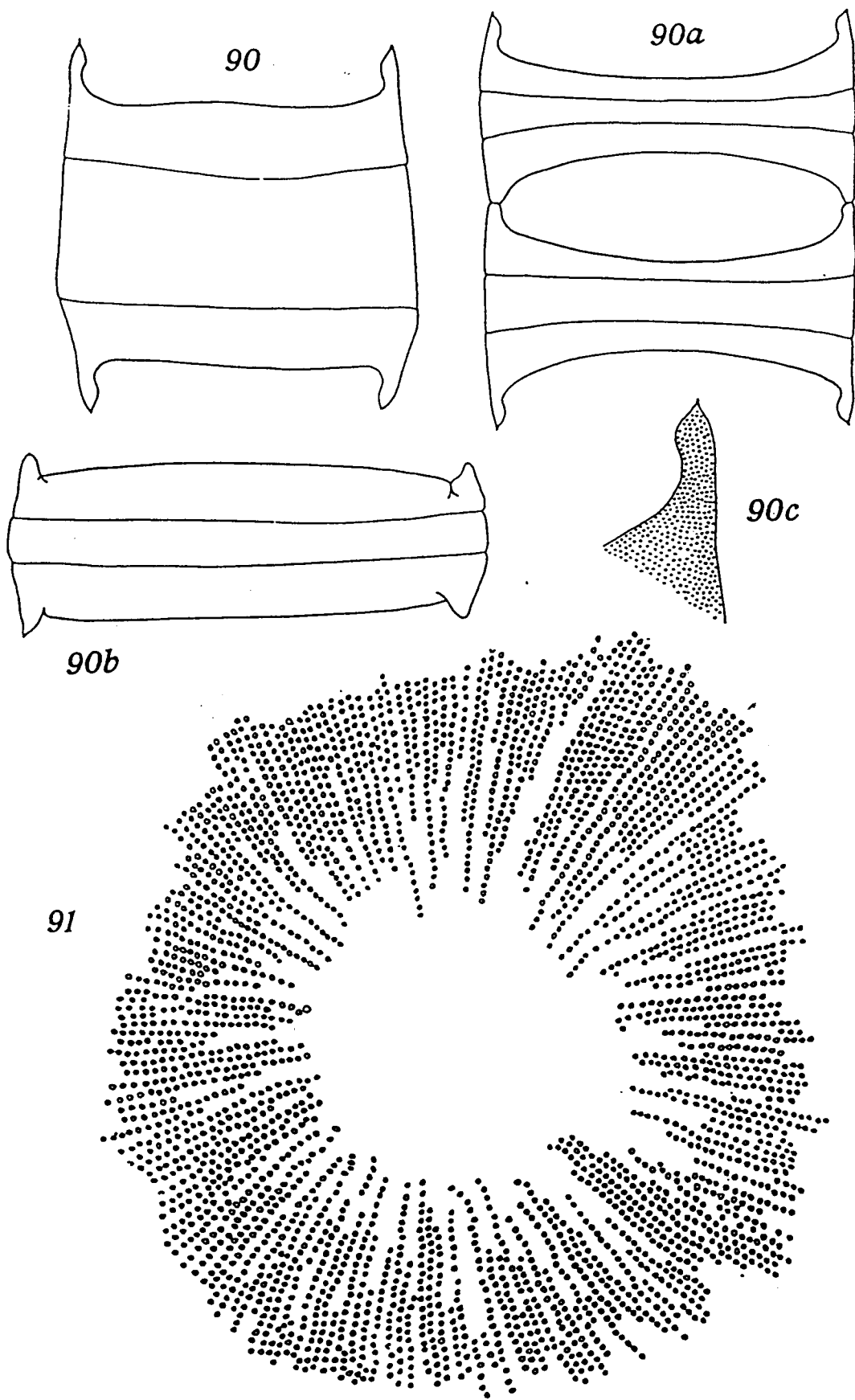

Figs. 90—91. 90. *Hemiaulus membranaceus*; 91. *Hemidiscus Hardmanianus*.

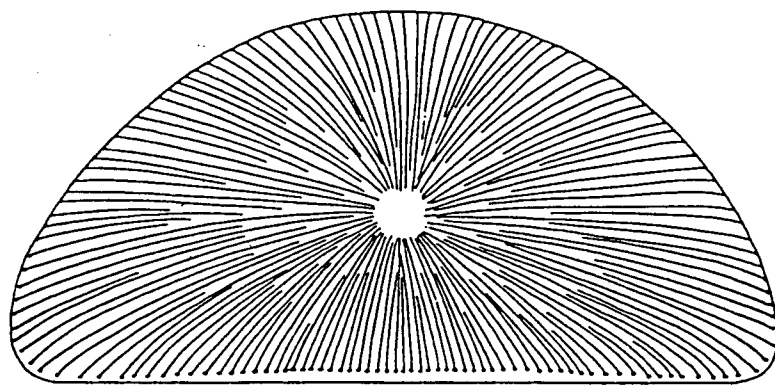

91a

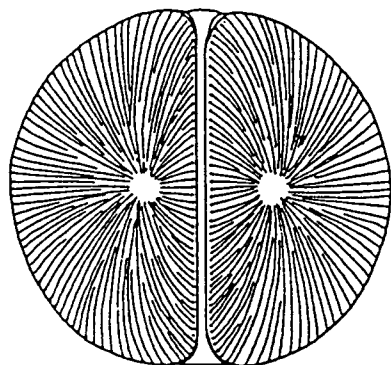

91d

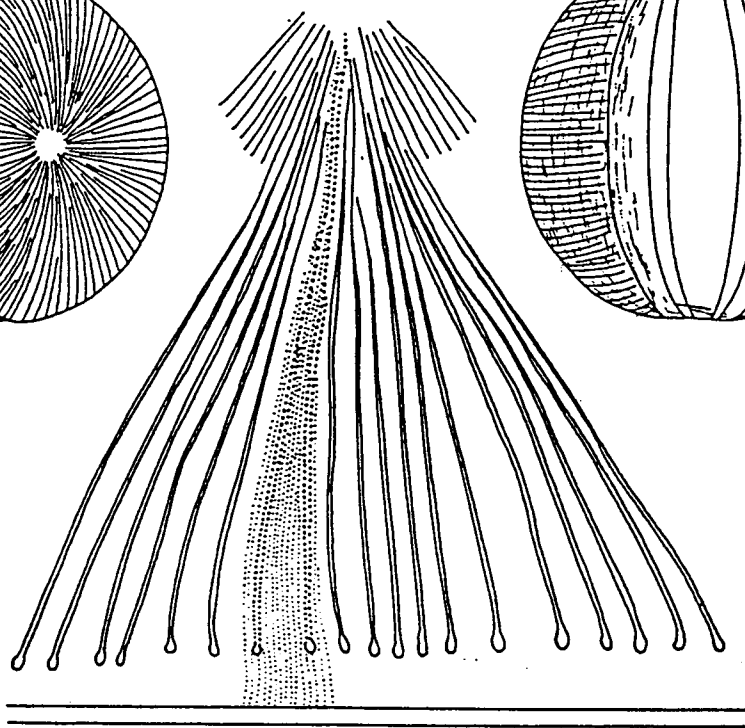

91b

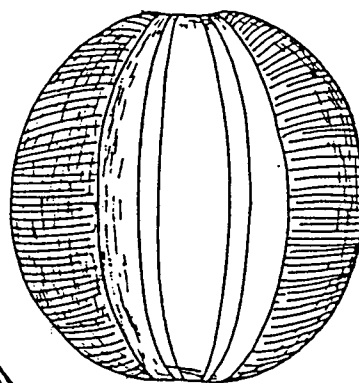

91e

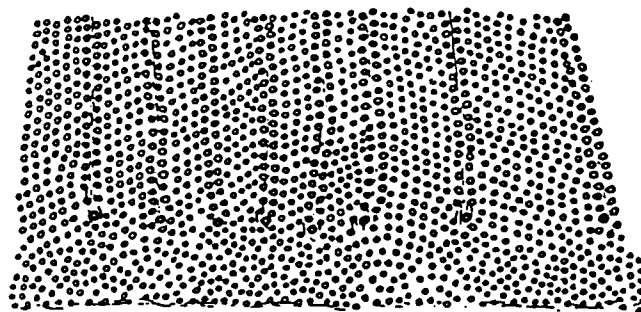

91c

Figs. 91a—91e. Hemidiscus Hardmanianus.

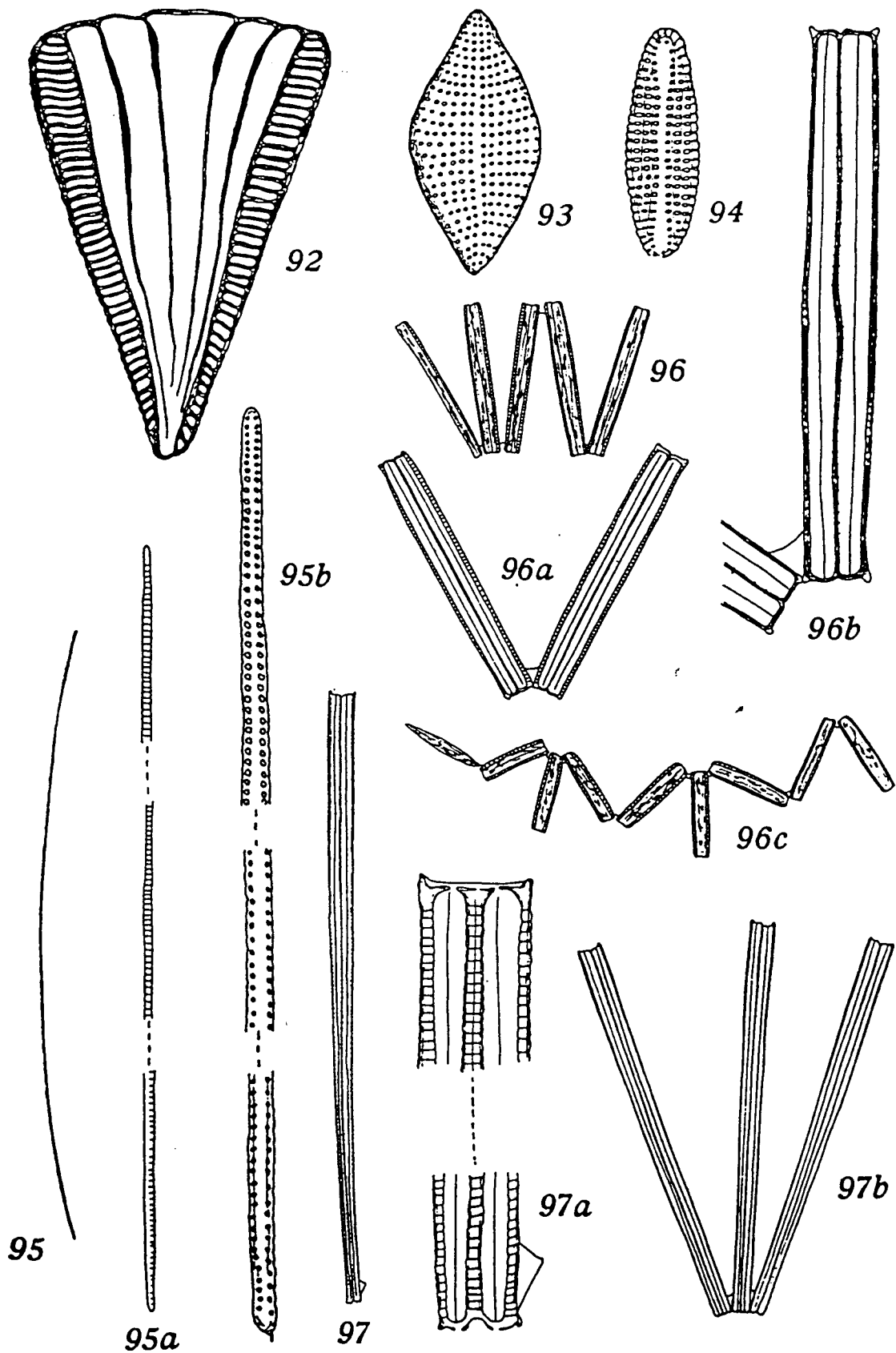

Figs. 92–97. 92. *Licmophora Lyngbyei*; 93. *Raphoneis amphiceros*; 94. *Raph. surirella*; 95. *Thalassiothrix elongata*; 96. *Thal. Nitzschioides*; 97. *Thal. Frauenfeldii*.

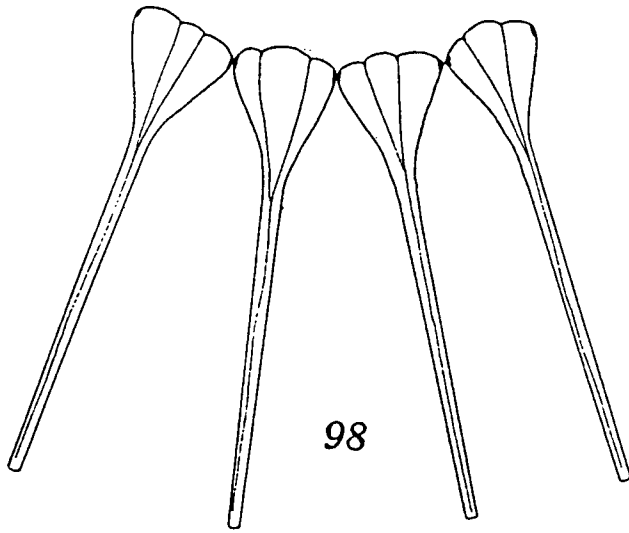

98



98a

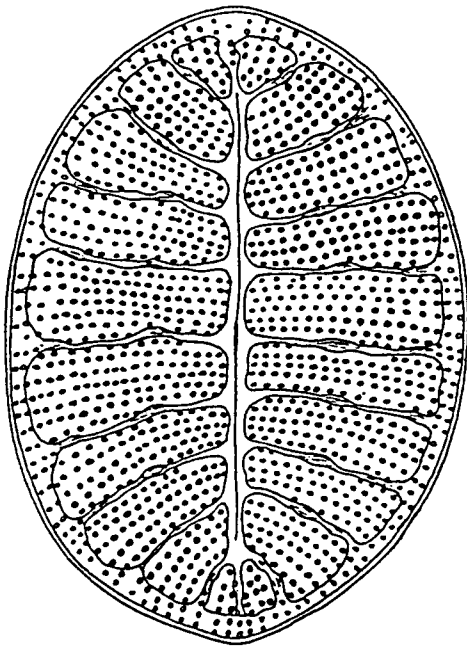

99

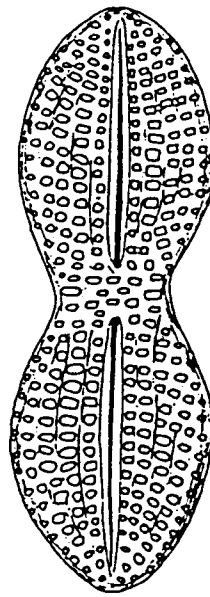

100

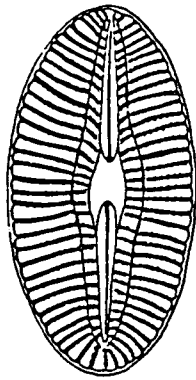

101

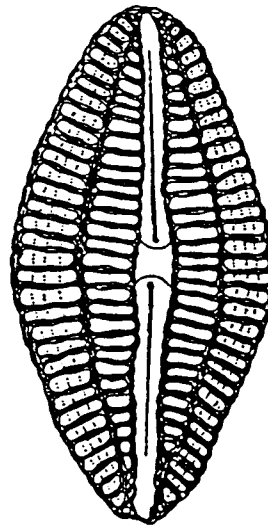

102

Figs. 98—102. 98. *Asterionella japonica*; 99. *Campyloneis Grevillei*; 100. *Navicula Weissflogii*; 101. *Navic. elliptica*; 102. *Navic. Pelagi*.

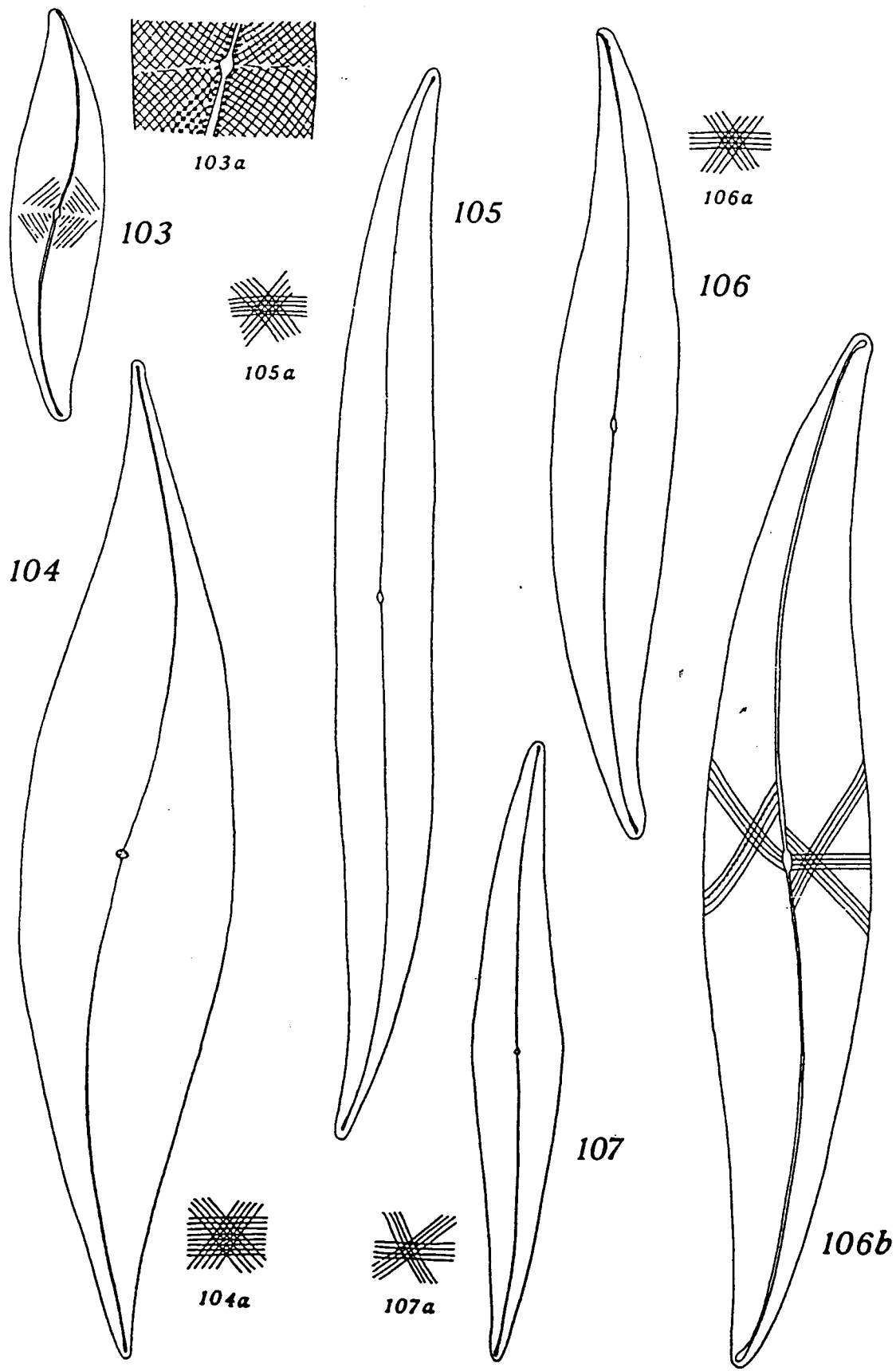

Figs. 103—107. 103. *Pleurosigma naviculaceum*; 104. *Pl. pelagicum*; 105. *Pl. elongatum*; 106. *Pl. Normanii*; 107. *Pl. angulatum*.



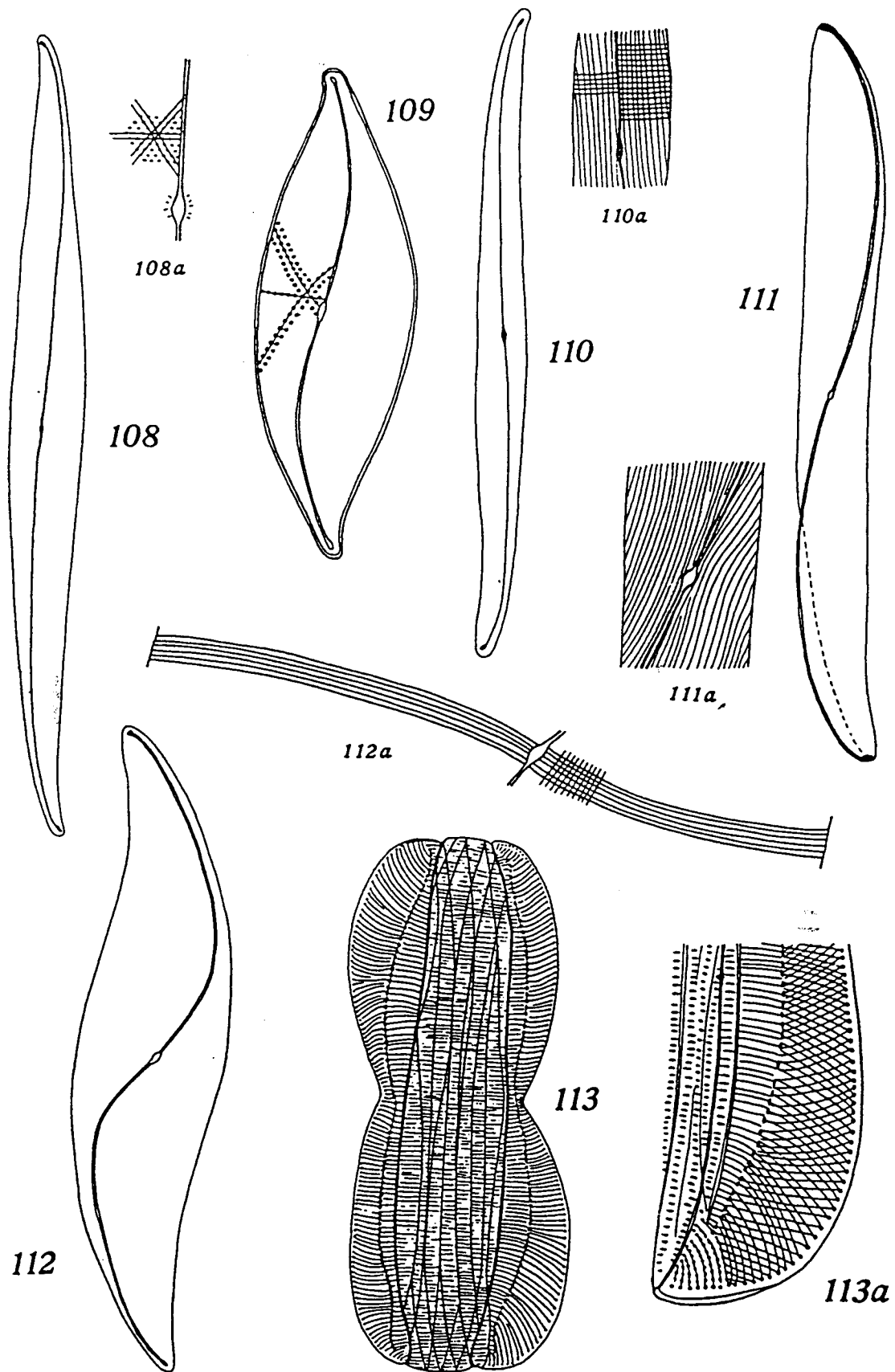

Figs. 108—113. 108. *Pleurosigma angulatum* var. *strigosa*; 109. *Pl. aestuarii*; 110. *Pl. Spencerii*; 111. *Pl. rectum*; 112. *Pl. compactum*; 113. *Amphiprora gigantea* var. *sulcata*.

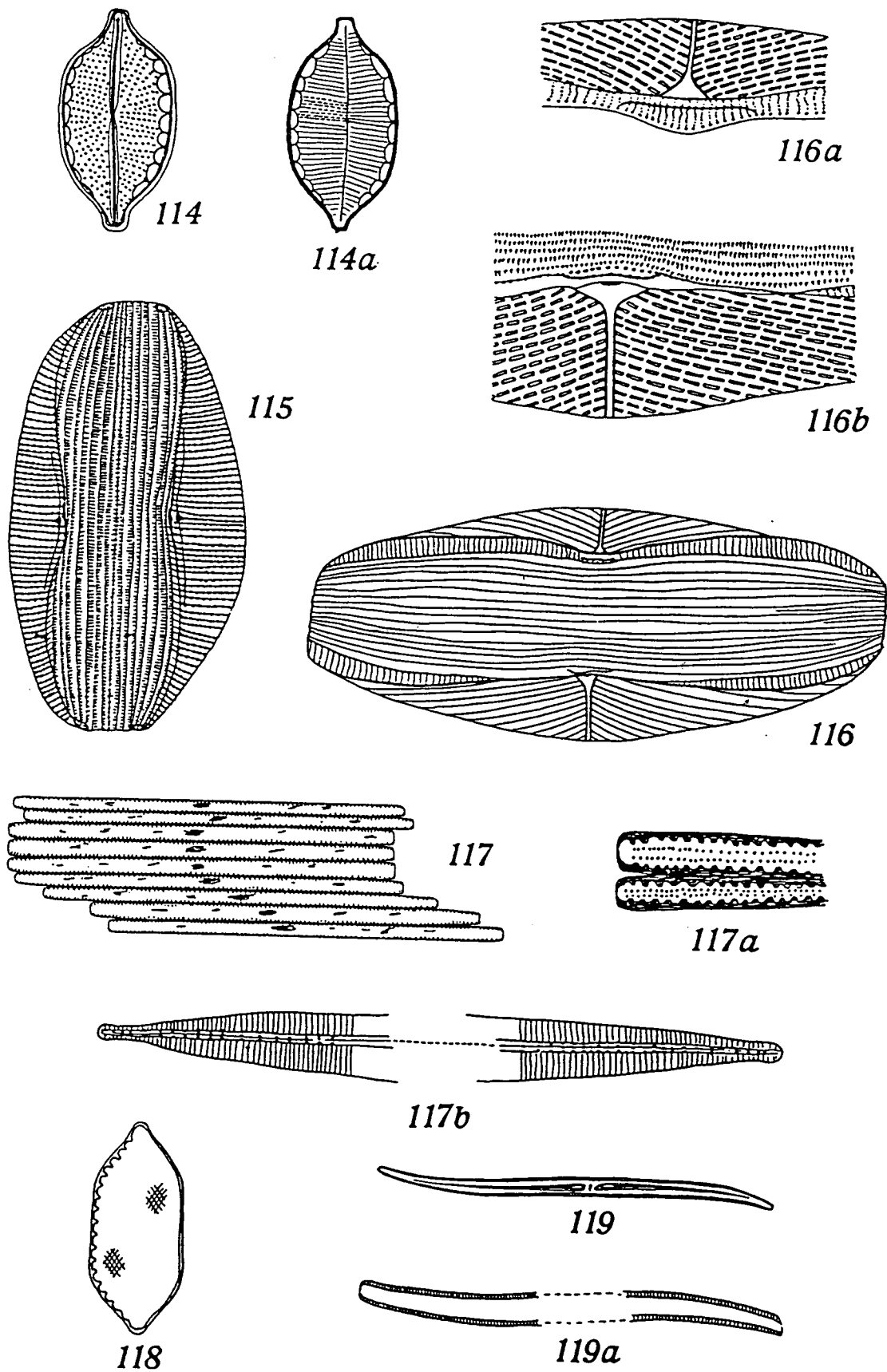

Figs. 114—119. 114. *Mastogloia minuta*; 115. *Amphora lineolata* var. *chinensis*; 116. *Am. decussata*; 117. *Bacillaria paradoxa*; 118. *Nitzschia panduriformis* var. *continua*; 119. *Nitz. sigma* var. *intercedens*.

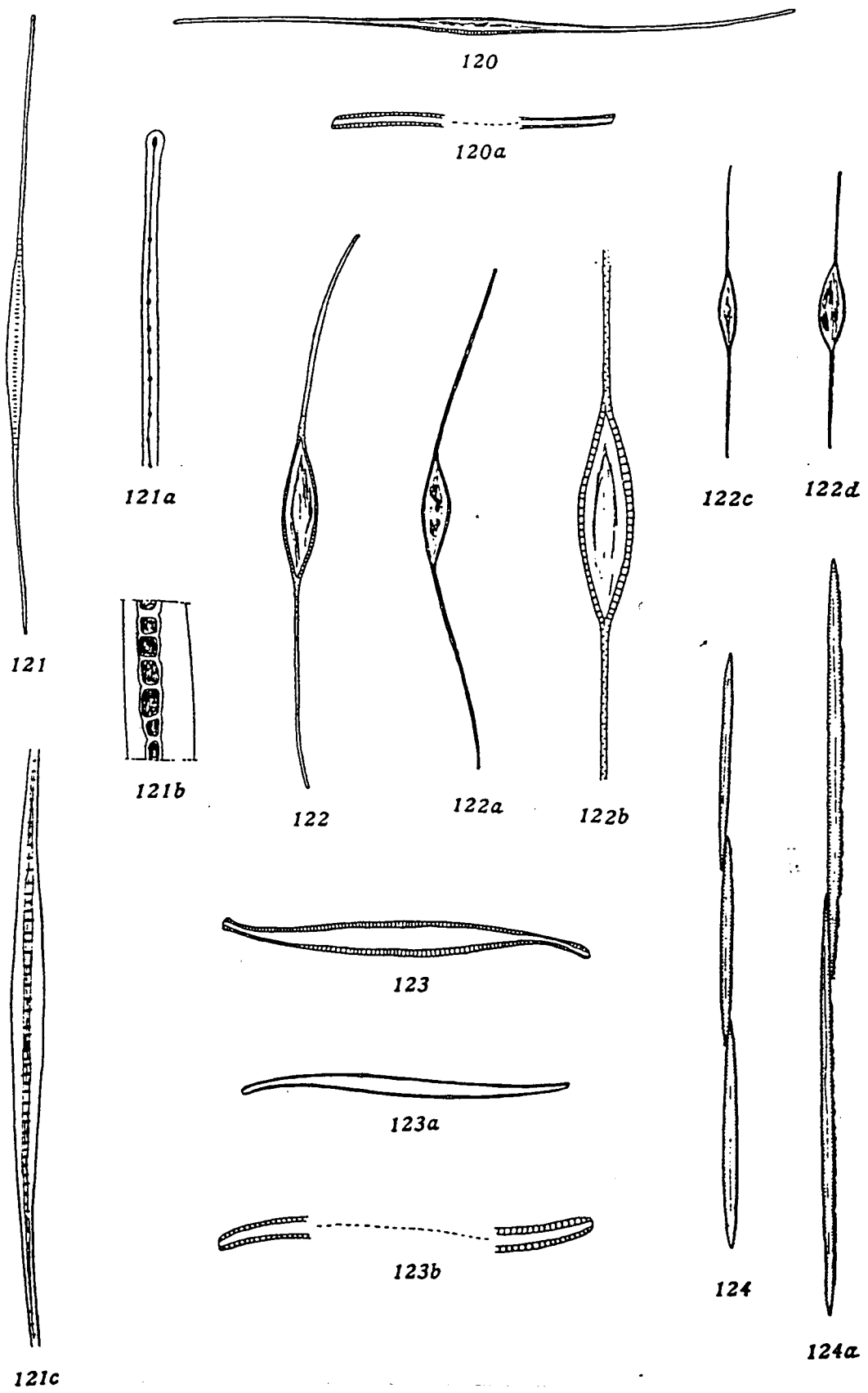

Figs. 120—124. 120. *Nitzschia sigma* var. *indica*; 121. *Nitz. longissima*; 122. *Nitz. Closterium*; 123. *Nitz. Lorenziana* var. *incurva*; 124. *Nitz. seriata*.

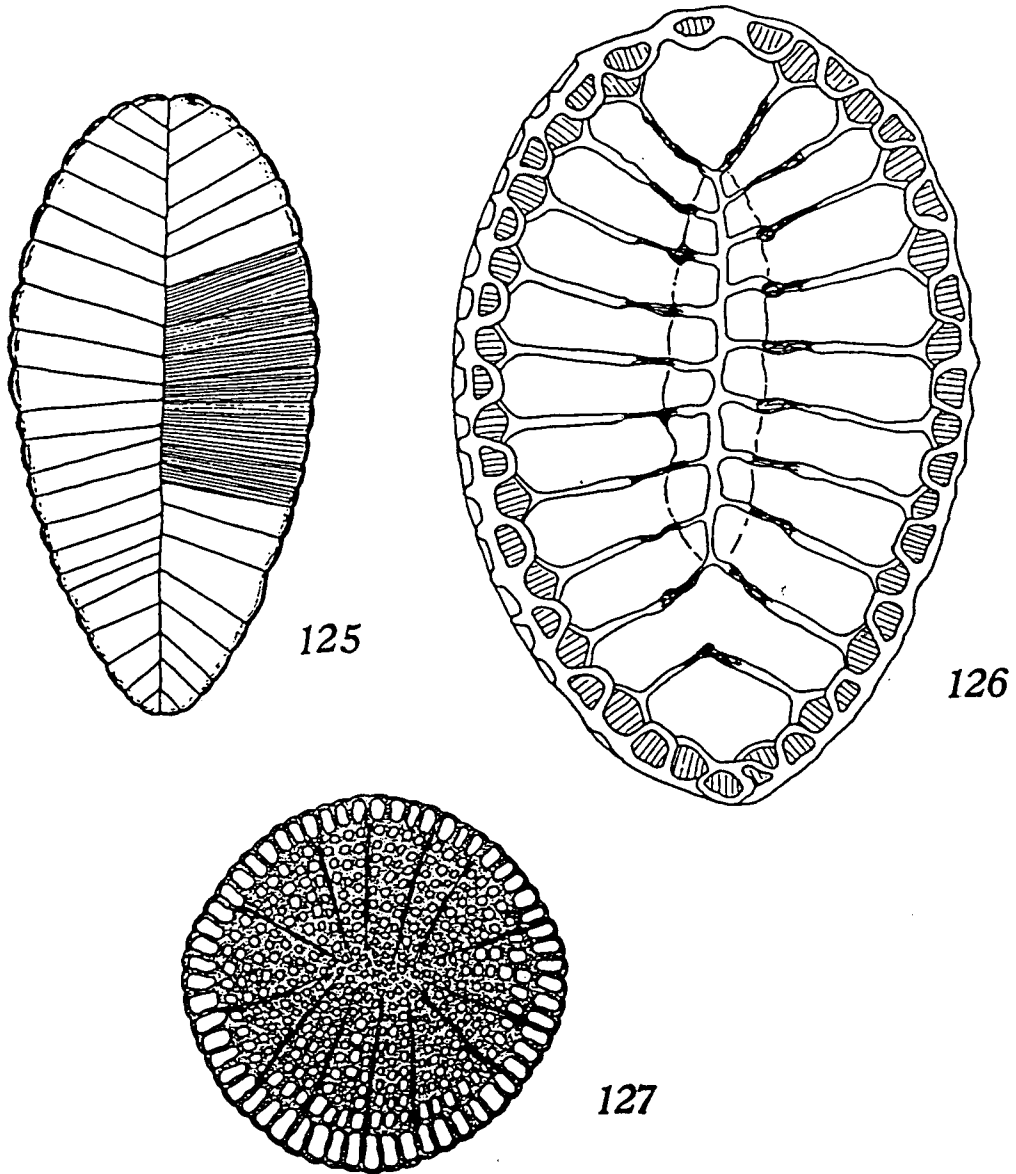

Figs. 125—127. 125. *Surirella gemma*; 126. *Sur. fluminensis*;  
127. *Campylodiscus* (?) *cocconeiformis*.